

ECM-EHL

Intel® Elkhart Lake 3.5" Micro Module

User's Manual

1st Ed –15 October 2021

FCC Statement



THIS DEVICE COMPLIES WITH PART 15 FCC RULES. OPERATION IS SUBJECT TO THE FOLLOWING TWO CONDITIONS:

- (1) THIS DEVICE MAY NOT CAUSE HARMFUL INTERFERENCE.
- (2) THIS DEVICE MUST ACCEPT ANY INTERFERENCE RECEIVED INCLUDING INTERFERENCE THAT MAY CAUSE UNDESIRE OPERATION.

THIS EQUIPMENT HAS BEEN TESTED AND FOUND TO COMPLY WITH THE LIMITS FOR A CLASS "A" DIGITAL DEVICE, PURSUANT TO PART 15 OF THE FCC RULES.

THESE LIMITS ARE DESIGNED TO PROVIDE REASONABLE PROTECTION AGAINST HARMFUL INTERFERENCE WHEN THE EQUIPMENT IS OPERATED IN A COMMERCIAL ENVIRONMENT. THIS EQUIPMENT GENERATES, USES, AND CAN RADIATE RADIO FREQUENCY ENERGY AND, IF NOT INSTALLED AND USED IN ACCORDANCE WITH THE INSTRUCTION MANUAL, MAY CAUSE HARMFUL INTERFERENCE TO RADIO COMMUNICATIONS.

OPERATION OF THIS EQUIPMENT IN A RESIDENTIAL AREA IS LIKELY TO CAUSE HARMFUL INTERFERENCE IN WHICH CASE THE USER WILL BE REQUIRED TO CORRECT THE INTERFERENCE AT HIS OWN EXPENSE.

Notice

This guide is designed for experienced users to setup the system within the shortest time. For detailed information, please always refer to the electronic user's manual.

Copyright Notice

Copyright © 2021 Avalue Technology Inc., ALL RIGHTS RESERVED.

No part of this document may be reproduced, copied, translated, or transmitted in any form or by any means, electronic or mechanical, for any purpose, without the prior written permission of the original manufacturer.

Trademark Acknowledgement

Brand and product names are trademarks or registered trademarks of their respective owners.

Disclaimer

Avalue Technology Inc. reserves the right to make changes, without notice, to any product, including circuits and/or software described or contained in this manual in order to improve design and/or performance. Avalue Technology assumes no responsibility or liability for the use of the described product(s), conveys no license or title under any patent, copyright, or masks work rights to these products, and makes no representations or warranties that

these products are free from patent, copyright, or mask work right infringement, unless otherwise specified. Applications that are described in this manual are for illustration purposes only. Avalue Technology Inc. makes no representation or warranty that such application will be suitable for the specified use without further testing or modification.

Life Support Policy

Avalue Technology's PRODUCTS ARE NOT FOR USE AS CRITICAL COMPONENTS IN LIFE SUPPORT DEVICES OR SYSTEMS WITHOUT THE PRIOR WRITTEN APPROVAL OF Avalue Technology Inc.

As used herein:

1. Life support devices or systems are devices or systems which, (a) are intended for surgical implant into body, or (b) support or sustain life and whose failure to perform, when properly used in accordance with instructions for use provided in the labeling, can be reasonably expected to result in significant injury to the user.
2. A critical component is any component of a life support device or system whose failure to perform can be reasonably expected to cause the failure of the life support device or system, or to affect its safety or effectiveness.

A Message to the Customer

Avalue Customer Services

Each and every Avalue's product is built to the most exacting specifications to ensure reliable performance in the harsh and demanding conditions typical of industrial environments. Whether your new Avalue device is destined for the laboratory or the factory floor, you can be assured that your product will provide the reliability and ease of operation for which the name Avalue has come to be known.

Your satisfaction is our primary concern. Here is a guide to Avalue's customer services. To ensure you get the full benefit of our services, please follow the instructions below carefully.

Technical Support

We want you to get the maximum performance from your products. So if you run into technical difficulties, we are here to help. For the most frequently asked questions, you can easily find answers in your product documentation. These answers are normally a lot more detailed than the ones we can give over the phone. So please consult the user's manual first.

To receive the latest version of the user's manual; please visit our Web site at:

<http://www.avalue.com.tw/>

Product Warranty

Avalue warrants to you, the original purchaser, that each of its products will be free from defects in materials and workmanship for two years from the date of purchase.

This warranty does not apply to any products which have been repaired or altered by persons other than repair personnel authorized by Avalue, or which have been subject to misuse, abuse, accident or improper installation. Avalue assumes no liability under the terms of this warranty as a consequence of such events. Because of Avalue's high quality-control standards and rigorous testing, most of our customers never need to use our repair service. If any of Avalue's products is defective, it will be repaired or replaced at no charge during the warranty period. For out-of-warranty repairs, you will be billed according to the cost of replacement materials, service time, and freight. Please consult your dealer for more details. If you think you have a defective product, follow these steps:

1. Collect all the information about the problem encountered. (For example, CPU type and speed, Avalue's products model name, hardware & BIOS revision number, other hardware and software used, etc.) Note anything abnormal and list any on-screen messages you get when the problem occurs.
2. Call your dealer and describe the problem. Please have your manual, product, and any helpful information available.
3. If your product is diagnosed as defective, obtain an RMA (return material authorization) number from your dealer. This allows us to process your good return more quickly.
4. Carefully pack the defective product, a complete Repair and Replacement Order Card and a photocopy proof of purchase date (such as your sales receipt) in a shippable container. A product returned without proof of the purchase date is not eligible for warranty service.
5. Write the RMA number visibly on the outside of the package and ship it prepaid to your dealer.

Content

1. Getting Started	8
1.1 Safety Precautions.....	8
1.2 Packing List.....	8
1.3 Document Amendment History	9
1.4 Manual Objectives.....	10
1.5 System Specifications	11
1.6 Architecture Overview—Block Diagram	14
2. Hardware Configuration	15
2.1 Product Overview.....	16
2.2 Jumper and Connector List.....	17
2.3 Setting Jumpers & Connectors	19
2.3.1 Serial port 1 pin9 signal select (JRI1)	19
2.3.2 Clear CMOS (JBAT1).....	19
2.3.3 AT/ATX Input power select (JAT1).....	20
2.3.4 LCD inverter connector (JBKL1)	20
2.3.5 CPU fan connector (CPU_FAN1).....	21
2.3.6 Serial port 1 in RS-422/485 mode (J422_485).....	21
2.3.7 Serial port 2 connector (JCOM2)	22
2.3.8 Serial port 3 connector (JCOM3)	22
2.3.9 Serial port 4 connector (JCOM4)	23
2.3.10 General purpose I/O connector (JDIO1).....	23
2.3.11 SATA Power connector (SATA_PWR1)	24
2.3.12 Power connector (PWR1)	24
2.3.13 USB2.0 connector (JUSB1)	25
2.3.14 BIOS SPI connector (BIOS_SPI1).....	25
2.3.15 EC Debug connector (JEC_ROM1).....	26
2.3.16 Battery connector (BT1).....	26
2.3.17 Front Panel connector (JFP1).....	27
2.3.18 PC Buzzer connector (JBZ1)	27
2.3.19 Cortex Debug + ETM connector (JPSE1).....	28
2.3.20 Port80 connector (JESPI1)	28
2.3.21 eDP connector (JEDP1).....	29
2.3.22 Audio connector (JAUDIO1)	29
2.3.22.1 Signal Description – Audio connector (JAUDIO1).....	29
3. BIOS Setup	30
3.1 Introduction	31

ECM-EHL User's Manual

3.2	Starting Setup	31
3.3	Using Setup	32
3.4	Getting Help	33
3.5	In Case of Problems	33
3.6	BIOS setup	34
3.6.1	Main Menu	34
3.6.1.1	System Language	35
3.6.1.2	System Date	35
3.6.1.3	System Time	35
3.6.2	Advanced Menu	35
3.6.2.1	CPU Configuration	36
3.6.2.2	Power & Performance	37
3.6.2.2.1	CPU – Power Management Control	37
3.6.2.2.2	GT – Power Management Control	39
3.6.2.3	PCH-FW Configuration	40
3.6.2.3.1	Firmware Update Configuration	40
3.6.2.3.2	PTT Configuration	41
3.6.2.4	Trusted Computing	41
3.6.2.5	APCI Settings	42
3.6.2.6	HW Monitor	42
3.6.2.7	NCT5124DSEC Super IO Configuration	43
3.6.2.7.1	Serial Port 1 Configuration	44
3.6.2.7.2	Serial Port 2 Configuration	44
3.6.2.7.3	Serial Port 3 Configuration	45
3.6.2.7.4	Serial Port 4 Configuration	45
3.6.2.8	S5 RTC Wake Settings	46
3.6.2.9	Serial Port Console Redirection	46
3.6.2.10	USB Configuration	47
3.6.2.11	Network Stack Configuration	48
3.6.2.12	NVMe Configuration	49
3.6.3	Chipset	49
3.6.3.1	System Agent (SA) Configuration	50
3.6.3.1.1	Memory Configuration	50
3.6.3.1.2	Graphics Configuration	51
3.6.3.2	PCH-IO Configuration	52
3.6.3.2.1	PCI Express Configuration	52
3.6.3.2.2	SATA Configuration	58
3.6.3.2.3	USB Configuration	59
3.6.3.2.4	HD Audio Configuration	60
3.6.3.3	Board & Panel Configuration	60

3.6.4	Security.....	62
3.6.4.1	Secure Boot.....	62
3.6.4.1.1	Key Management.....	63
3.6.5	Boot.....	64
3.6.6	Save and exit.....	65
3.6.6.1	Save Changes and Exit.....	65
3.6.6.2	Discard Changes and Exit.....	66
3.6.6.3	Save Changes and Reset.....	66
3.6.6.4	Discard Changes and Reset.....	66
3.6.6.5	Save Changes.....	66
3.6.6.6	Discard Changes.....	66
3.6.6.7	Restore Defaults.....	66
3.6.6.8	Save as User Defaults.....	66
3.6.6.9	Restore User Defaults.....	66
4.	Drivers Installation.....	67
4.1	Install Chipset Driver.....	68
4.2	Install ME Driver.....	69
4.3	Install VGA Driver.....	70
4.4	Install Display Audio Driver.....	71
4.5	Install Ethernet Driver.....	73
4.6	Install HID Driver.....	75
4.7	Install SIO Driver.....	76
5.	Mechanical Drawing.....	77

1. Getting Started

1.1 Safety Precautions

Warning!



Always completely disconnect the power cord from your chassis whenever you work with the hardware. Do not make connections while the power is on. Sensitive electronic components can be damaged by sudden power surges. Only experienced electronics personnel should open the PC chassis.

Caution!



Always ground yourself to remove any static charge before touching the CPU card. Modern electronic devices are very sensitive to static electric charges. As a safety precaution, use a grounding wrist strap at all times. Place all electronic components in a static-dissipative surface or static-shielded bag when they are not in the chassis.

1.2 Packing List

Before you begin installing your single board, please make sure that the following materials have been shipped:

- 1 x 3.5" ECM-EHL Micro Module
- 1 x CPU Heatsink
- 1 x Cable set contains the followings:
 - 1 x Serial ATA cable (7-pin, standard)
 - 1 x Wire SATA power cable (15-pin, 2P/2.0mm)
 - 1 x Flat cable 9P(M)-PHD 10P/2.0mm)
- 3M foam (VHB-4622 10mm*20mm*1.1mm)



If any of the above items is damaged or missing, contact your retailer.

1.3 Document Amendment History

Revision	Date	By	Comment
1 st	October 2021	Avalue	Initial Release

1.4 Manual Objectives

This manual describes in details Avalue Technology ECM-EHL Single Board.

We have tried to include as much information as possible but we have not duplicated information that is provided in the standard IBM Technical References, unless it proved to be necessary to aid in the understanding of this board.

We strongly recommend that you study this manual carefully before attempting to set up ECM-EHL or change the standard configurations. Whilst all the necessary information is available in this manual we would recommend that unless you are confident, you contact your supplier for guidance.

Please be aware that it is possible to create configurations within the CMOS RAM that make booting impossible. If this should happen, clear the CMOS settings, (see the description of the Jumper Settings for details).

If you have any suggestions or find any errors regarding this manual and want to inform us of these, please contact our Customer Service department with the relevant details.

1.5 System Specifications

System	
CPU	Onboard Intel® Pentium®/Celeron®/Atom™ SoC BGA Processor (Elkhart Lake Platform 4.5~12W)- (with CPU Bottom Mounted) Intel® Celeron® J6412 processor, Quad core,2 GHz,10W Intel® Celeron® J6413 processor, Quad core,1.8GHz,10W Intel® Pentium® J6426 processor, Quad core,2 GHz,10W Intel® Atom® x6211E processor, Dual core,1.2GHz,6W Intel® Atom® x6413E processor, Quad core,1.5GHz,9W Intel® Atom® x6425E processor, Quad core,1.8GHz,12W Intel® Atom® x6212RE processor, Dual core,1.2GHz,6W Intel® Atom® x6414RE processor, Quad core,1.5GHz,9W Intel® Atom® x6425RE processor, Quad core,1.9GHz,12W
BIOS	AMI BIOS, 256Mbit SPI Flash ROM
Chipset	Elkhart lake SoC integrated
I/O Chip	EC ITE IT5571
Memory	Single 260-pin DDR4 SODIMM Socket, Supports Up to 32GB DDR4 3200MT/s SDRAM (non ECC Supported)
Watchdog Timer	H/W Reset, 1sec. ~ 65535sec and 1sec. or 1min./step
H/W Status Monitor	CPU & system temperature monitoring Voltages monitoring
TPM	TPM 2.0 NuvoTon_NPCT750AADYX(for standard temp) & NPCT754AADYX(for extend temp) co-lay Infineon_SLB9670VQ2.0 Default is NuvoTon
Expansion	
M.2	1 x M.2 Key-B 2242/3042, (PCIex2) or (PCIex1+USB3.1 GEN 1) or (SATAIII + USB 3.1 GEN1), USB2.0, with SIM Slot for SSD/LTE. *Default is PCIex1/SATAIII+USB3.1 GEN1 1 x M.2 (Key-E, 2230, PCIex1, USB2.0)
Storage	
M.2	1 x M.2 (Key-B, 2242)
SATA Interface	1 x SATA III
Edge I/O	
COM	1x 2x 3pin (2.0mm) for RS422/485 switch by GPIO 1 x D-SUB9 RS232
LAN	2 x RJ45 (Independent)

ECM-EHL User's Manual

USB 2.0	2 x USB 2.0 (Dual Deck, Type A)
USB 3.1	2 x USB 3.1 Gen.2 (Dual Deck, Type A)
DP	1 x DP++ 1.4a (Dual Deck with HDMI)
HDMI	1 x HDMI 2.0b (Dual Deck with DP)
LED Indicator	2 x LED for Power and Data Access (Dual Deck)
Onboard I/O	
SATA Power	1 x 2-Pin Wafer (2.0mm) for 5V Power SATA Power
COM Port	3 x 2 x 5pin (2.0mm) for 3xRS232(COM2/3/4)
USB 2.0	1 x 2 x 5-Pin Header (2.0mm) for USB2.0
GPIO	1 x 2 x 6-Pin Header (2.0mm) for 8-bit GPIO, SMBUS, +5V, GND
Audio	1 x 2 x 6-Pin Header (2.0mm) for Line-In, Line-Out, Mic-In
CPU FAN	1 x 4-Pin Header Connector (2.54mm) for Smart Fan
Buzzer	1 x 2-Pin Wafer (2.0mm)
Front Panel	1 x 2 x 5-Pin Header (2.00mm)
RTC Battery	1 x 2-Pin Wafer (1.25mm) CR2032X
AT/ATX Selector	1 x 3-Pin Header (2.0mm), Default is AT
Clear CMOS	1 x 3-Pin Header (2.0mm)
eDP	1 x 2 x 10 pin wafer(1.25mm)
LCD Backlight Brightness	1 x 3-Pin Header (2.0mm)
LCD Inverter	1 x 5-Pin Wafer (2.0mm)
eSPI	1 x 2 x 6-Pin Header (1.27mm)
DC Input	1 x 2 x 2-Pin 180D Connector (4.2mm)
Display	
Graphic Chipset	Intel® Elkhart Lake SoC Processor integrated Gen11 LP graphics
Spec. & Resolution	HDMI 2.0b Max resolution 4096x2160@60Hz DP 1.4a Max resolution 4096x2160@60Hz eDP1.3 Max resolution 4096x2160@60Hz
Multiple Display	Triple Display
Audio	
AC97 Codec	92HD73C Tempo
Interface	Mic-In, Line-In, Line-Out in pin header
Ethernet	
LAN Chip	Intel® I225LM, I210AT for standard temperature Intel® I225-IT, I210IT for extend temperature
Ethernet Spec.	1 x 10/100/1000/2.5G Base-Tx GbE compatible, 2.5G support up to 70°C Ta base on Intel spec, above 70°C Ta, the recommended speed is 1G. 1 x 10/100/1000 Base-Tx GbE compatible

Interface	2 x RJ45
Mechanical & Environmental	
Power Requirement	Typical 12/24Vdc (+9~ 36Vdc)
ACPI	Single power ATX Support S0,S3, S4, S5 ACPI 5.0 Compliant
Power Type	AT/ATX (Default Setting: AT)
Operating Temp.	Operating Standard: 0°C ~ 60°C with 0.5m/s air flow Conditional extend: -40°C ~ 85°C with 0.5m/s air flow. Note. 2.5G LAN IC support up to 70°C Ta base on Intel spec. Above 70°C Ta, the recommended speed is 1G.
Storage Temp.	-40°C ~ 85°C (-40°F ~ 185°F)
Operating Humidity	40°C @ 95% Relative Humidity, Non-condensing
Size (L x W)	5.7" x 4" (146mm x 101mm) (Please consult product engineers for the production feasibility if the size is larger than 410x360mm or smaller than 80x70mm)
Weight	0.44 lbs (0.2 Kg)
Vibration Test	1.5Grms, IEC 60068-2-64, Random, 5 ~ 500Hz, 30min/Axis, 3 Axis
Shock Test	10G, IEC 60068-2-27, Half Sine, 11ms, Z Axis
Drop Test	ISTA 2A, IEC-60068-2-32 Test : Ed, 1 Corner, 3 Edges, 6 Faces
OS Support (listed in accordance with Intel document)	Windows 10 Linux



Note: Specifications are subject to change without notice.

User condition suggestion:

- Tempo Semiconductor 92HD73C1T5 Audio Codec, MIC-IN OS default setting
Microphone: 86 / Microphone Boost: +10%, different Microphone may have sound reception vary leading noise, customer can manually turn off boost.
- Intel® Ethernet Controller I225-LM/IT temperature measurement data stated in Avalue Board Product Design Verification Report, Intel does not provide official temperature guide or tool for TC measurement.

1.6 Architecture Overview—Block Diagram

The following block diagram shows the architecture and main components of ECM-EHL

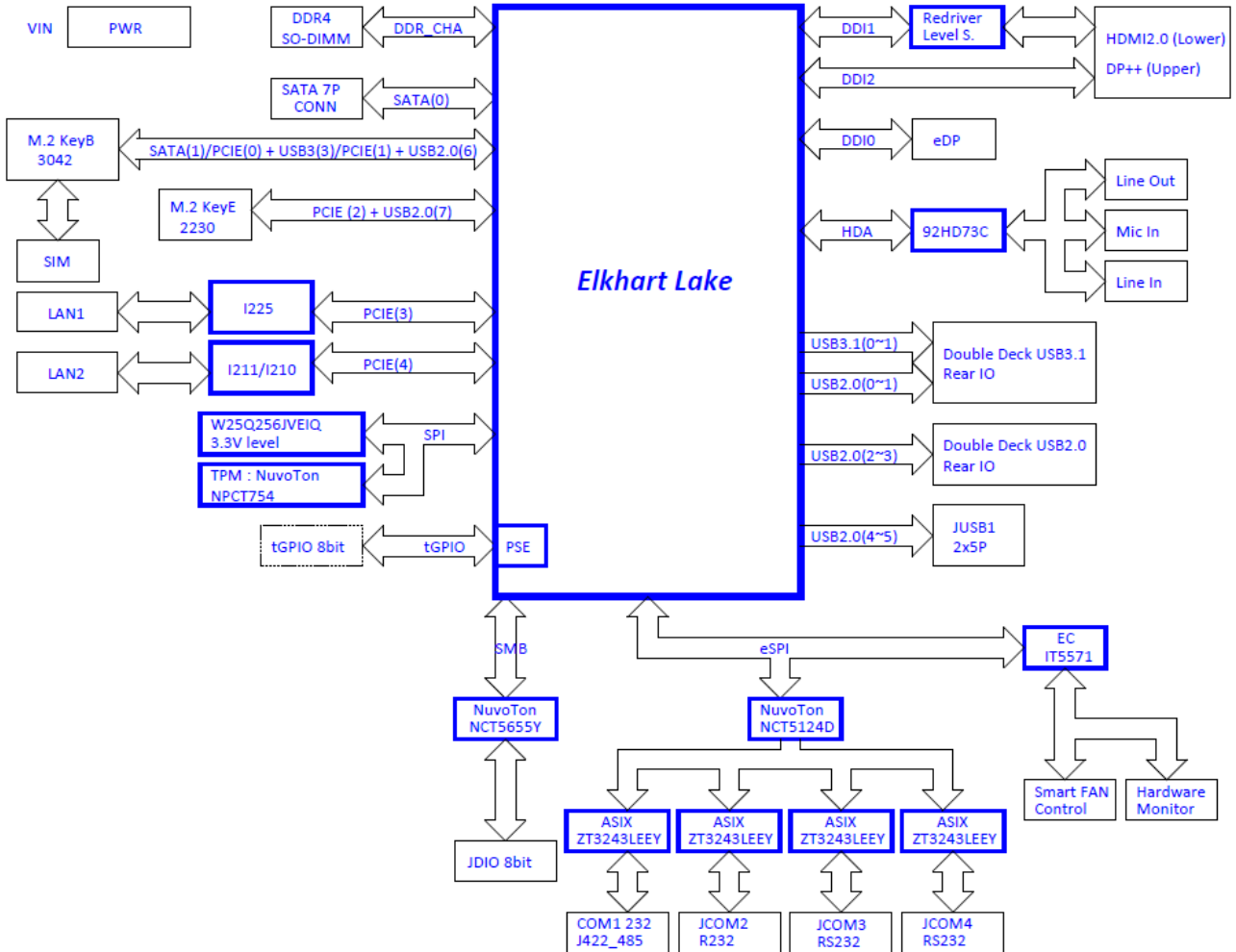

2. Hardware Configuration

2.1 Product Overview

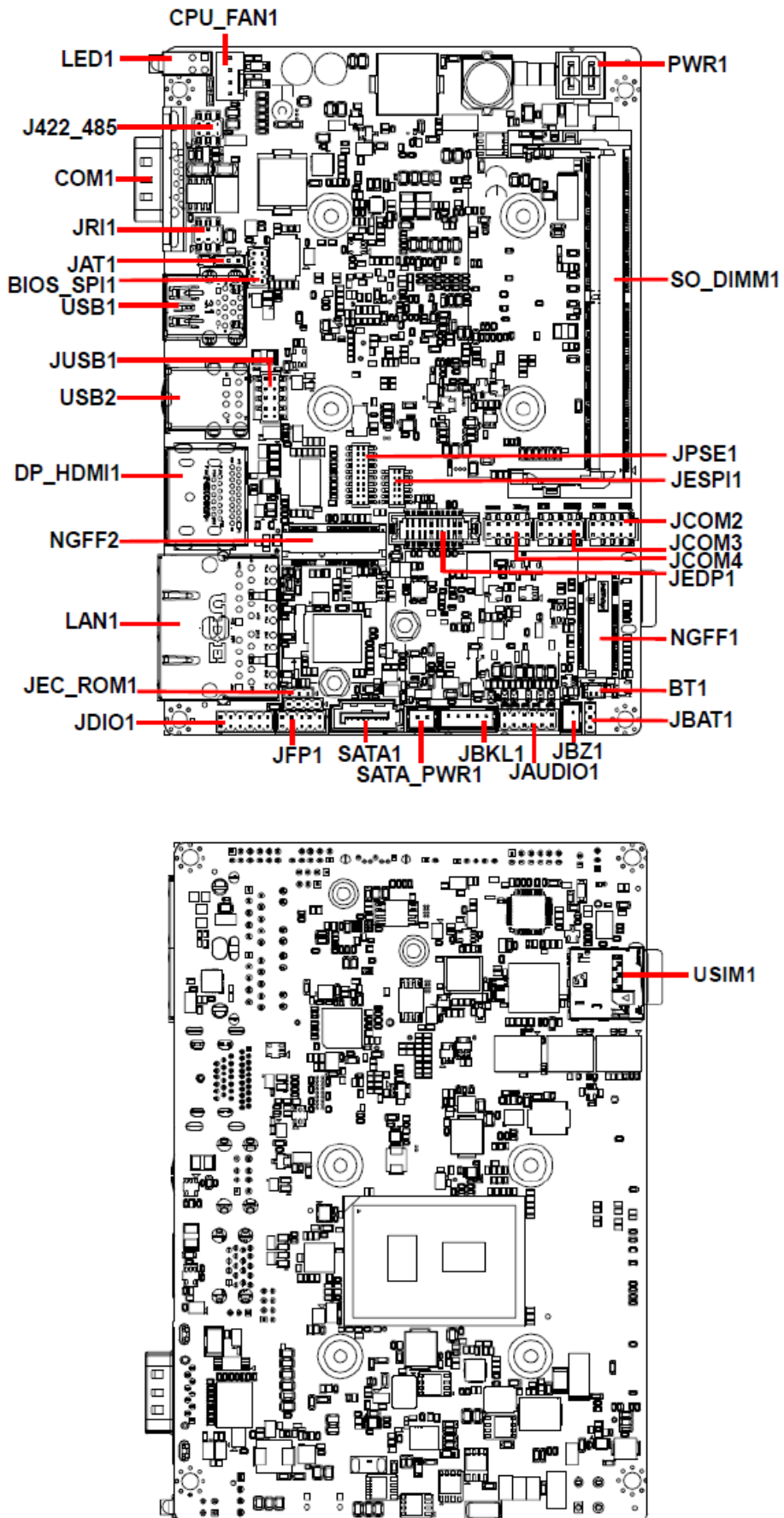

2.2 Jumper and Connector List

You can configure your board to match the needs of your application by setting jumpers. A jumper is the simplest kind of electric switch.

It consists of two metal pins and a small metal clip (often protected by a plastic cover) that slides over the pins to connect them. To “close” a jumper you connect the pins with the clip. To “open” a jumper you remove the clip. Sometimes a jumper will have three pins, labeled 1, 2, and 3. In this case, you would connect either two pins.

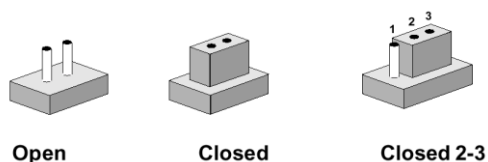

The jumper settings are schematically depicted in this manual as follows:

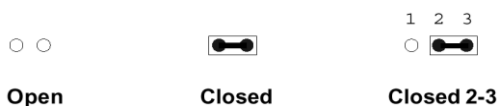

A pair of needle-nose pliers may be helpful when working with jumpers.

Connectors on the board are linked to external devices such as hard disk drives, a keyboard, or floppy drives. In addition, the board has a number of jumpers that allow you to configure your system to suit your application.

If you have any doubts about the best hardware configuration for your application, contact your local distributor or sales representative before you make any changes.

The following tables list the function of each of the board's jumpers and connectors.

Jumpers

Label	Function	Note
JRI1	Serial port 1 pin9 signal select	3 x 2 header, pitch 2.00mm
JAT1	AT/ATX Input power select	3 x 1 header, pitch 2.00mm
JBAT1	Clear CMOS	3 x 1 header, pitch 2.00mm

Connectors

Label	Function	Note
JBKL1	LCD inverter connector	5 x 1 wafer, pitch 2.00mm Matching Connector: JST PHR-5
CPU_FAN1	CPU fan connector	4 x 1 wafer, pitch 2.54mm
COM1	Serial Port 1 connector	D-sub 9-pin, male Note : COM1 support RS422/485 by BIOS setting
J422_485	Serial port 1 in RS-422/485 mode	3 x 2 header, pitch 2.00 mm

ECM-EHL User's Manual

JCOM2/3/4	Serial Port 2/3/4 connector	5 x 2 header, pitch 2.00mm
JDIO1	General purpose I/O connector	6 x 2 wafer, pitch 2.00mm
NGFF1	M.2 KEY-B 2242/3042 connector	
NGFF2	M.2 KEY-E 2230 connector	
LED1	HDD/Power LED indicator	
JFP1	Front Panel connector	5 x 2 header, pitch 2.00mm
USB1	2 x USB3.1 connector	
USB2	2 x USB2.0 connector	
JUSB1	USB2.0 connector	5 x 2 header, pitch 2.00mm
JBZ1	PC Buzzer connector	2 x 1 wafer, pitch 2.00mm
LAN1	2 x RJ-45 Ethernet	
BT1	Battery connector	2 x 1 wafer, pitch 1.25mm
JAUDIO1	Audio connector	6 x 2 header, pitch 2.00mm
PWR1	Power connector	2 x 2 wafer, pitch 4.20mm
BIOS_SPI1	BIOS SPI connector	4 x 2 header, pitch 2.00mm
JEC_ROM1	EC Debug connector	3 x 1 header, pitch 2.00mm
SATA_PWR1	SATA Power connector	2 x 1 wafer, pitch 2.00mm
SATA1	Serial ATA connector	
DP_HDMI1	DP connector HDMI connector	
SO_DIMM1	DDR4 SODIMM socket	
JPSE1	Cortex Debug + ETM connector	10 x 2 header, pitch 1.27mm
JESPI1	Port80 connector	6 x 2 header, pitch 1.27mm
JEDP1	eDP connector	10 x 2 wafer, pitch 1.25mm
USIM1	SIM card slot	

2.3 Setting Jumpers & Connectors

2.3.1 Serial port 1 pin9 signal select (JRI1)

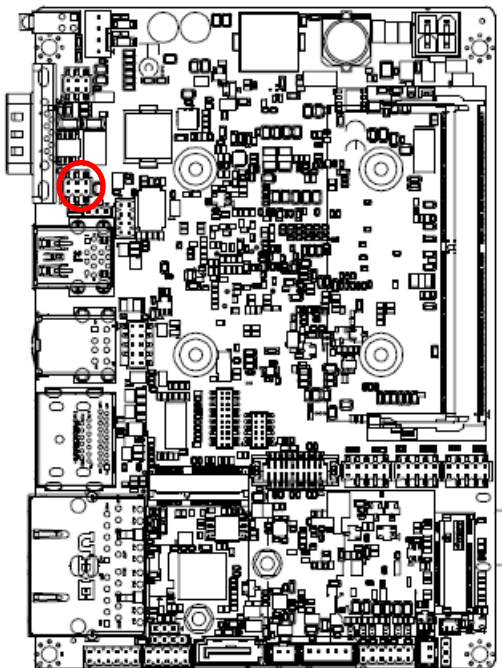

Ring*

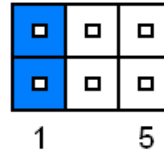

+5V

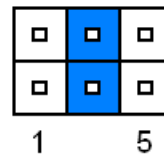

+12V

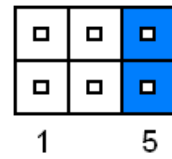

* Default

2.3.2 Clear CMOS (JBAT1)

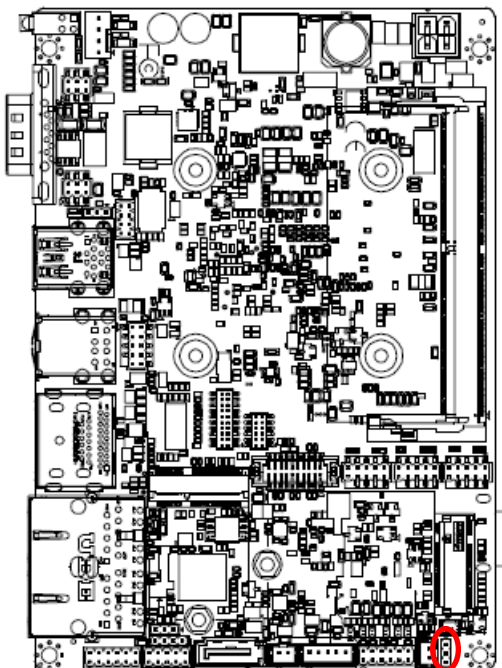

Normal*

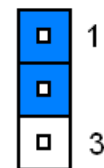

Clear CMOS

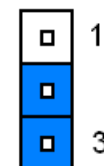

* Default

2.3.3 AT/ATX Input power select (JAT1)

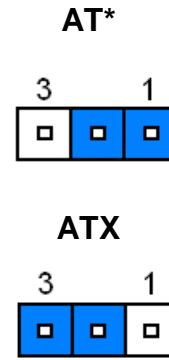
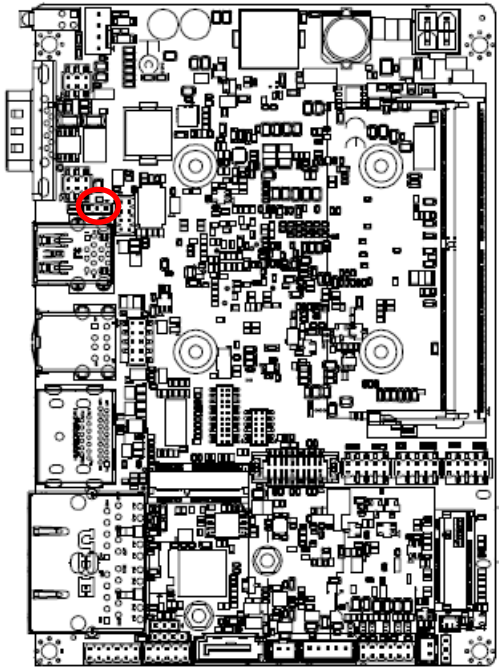

* Default

2.3.4 LCD inverter connector (JBKL1)

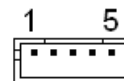
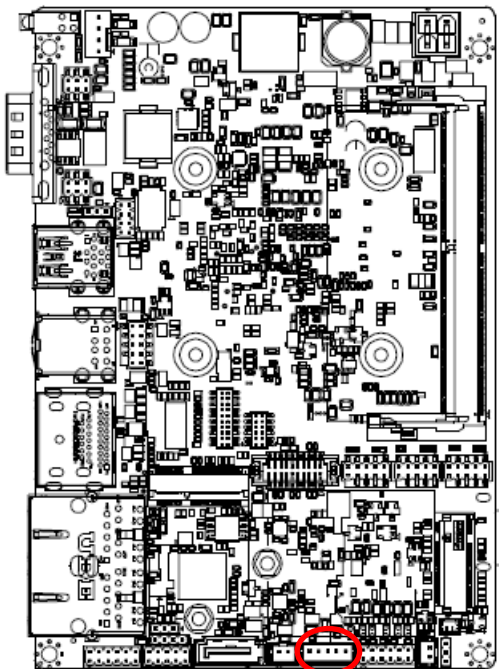

Signal	PIN
+12V	1
GND	2
BKLEN	3
VBRIGHT	4
+5V	5

2.3.5 CPU fan connector (CPU_FAN1)

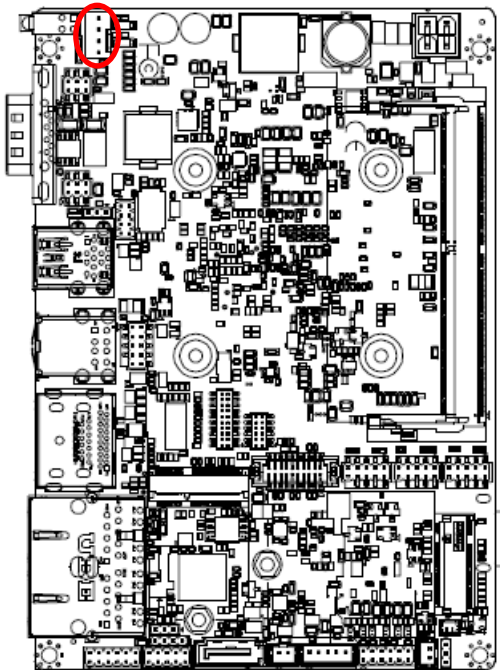

Signal	PIN
CFAN_OUT_PWM	4
CFAN_IN_TACH	3
+12V	2
GND	1

2.3.6 Serial port 1 in RS-422/485 mode (J422_485)

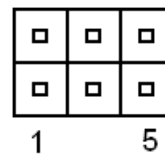
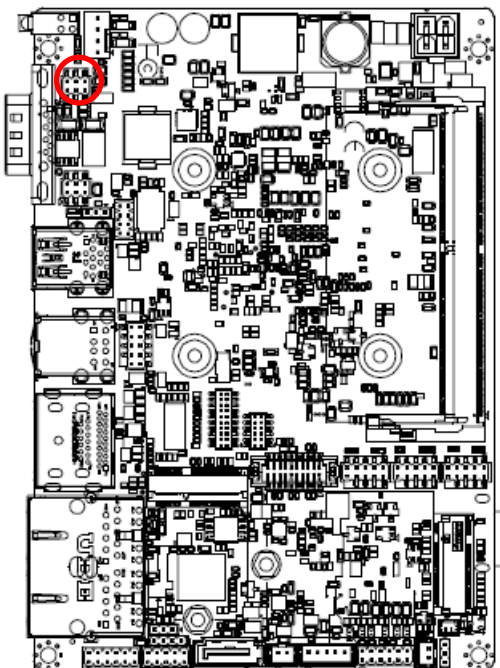

Signal	PIN	PIN	Signal
485TX2-	1	2	485TX2+
485RX2+	3	4	485RX2-
+5V	5	6	GND

2.3.7 Serial port 2 connector (JCOM2)

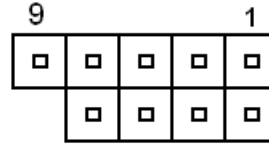
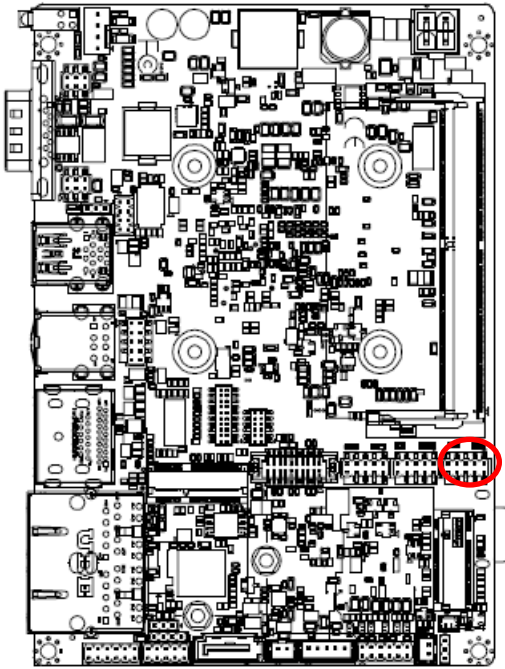

Signal	PIN	PIN	Signal
COM_DCD#_2	1	2	COM_RXD_2
COM_TXD_2	3	4	COM_DTR#_2
GND	5	6	COM_DSR#_2
COM_RTS#_2	7	8	COM_CTS#_2
COM_RI#_2	9		

2.3.8 Serial port 3 connector (JCOM3)

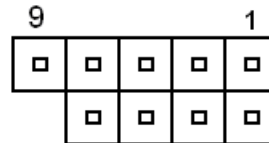
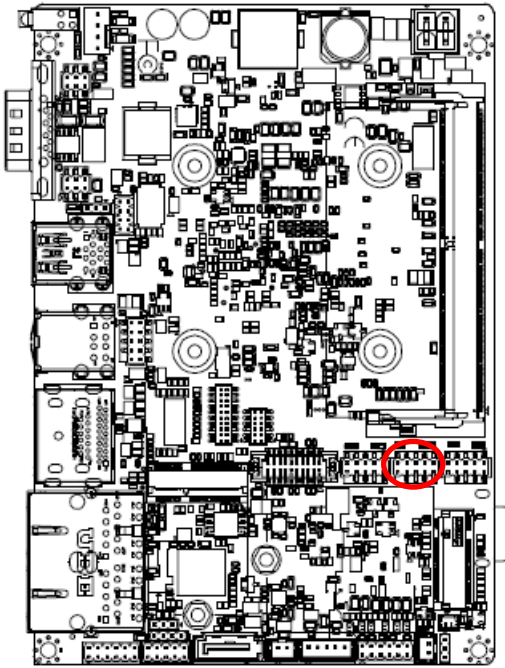

Signal	PIN	PIN	Signal
COM_DCD#_3	1	2	COM_RXD_3
COM_TXD_3	3	4	COM_DTR#_3
GND	5	6	COM_DSR#_3
COM_RTS#_3	7	8	COM_CTS#_3
COM_RI#_3	9		

2.3.9 Serial port 4 connector (JCOM4)

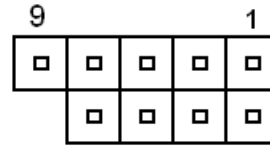
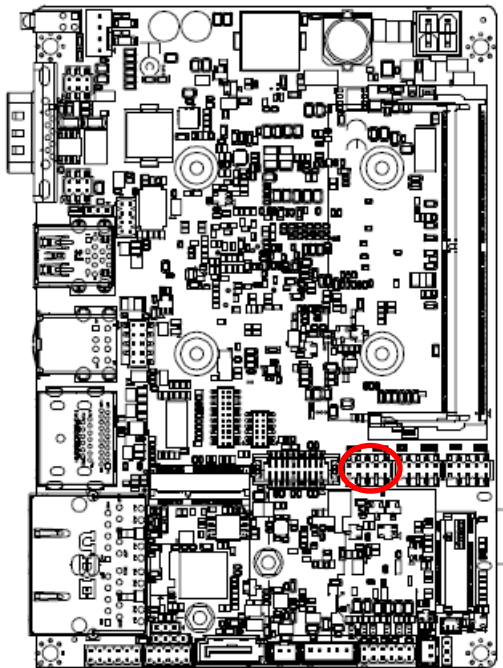

Signal	PIN	PIN	Signal
COM_DCD#_4	1	2	COM_RXD_4
COM_TXD_4	3	4	COM_DTR#_4
GND	5	6	COM_DSR#_4
COM_RTS#_4	7	8	COM_CTS#_4
COM_RI#_4	9		

2.3.10 General purpose I/O connector (JDIO1)

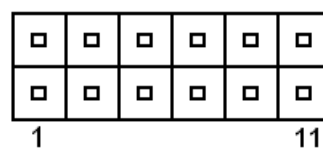
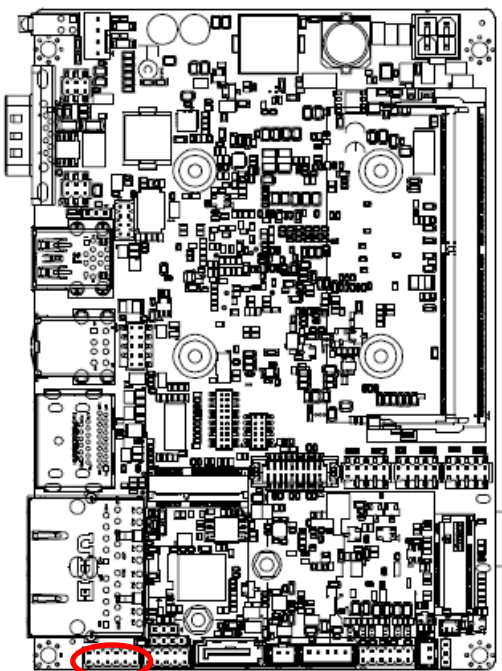

Signal	PIN	PIN	Signal
DIO_GP20_TGPI4	1	2	DIO_GP10_TGPI0
DIO_GP21_TGPI5	3	4	DIO_GP11_TGPI1
DIO_GP22_TGPI6	5	6	DIO_GP12_TGPI2
DIO_GP23_TGPI7	7	8	DIO_GP13_TGPI3
SMB_SCL_S0	9	10	SMB_SDA_S0
GND	11	12	+5V

2.3.11 SATA Power connector (SATA_PWR1)

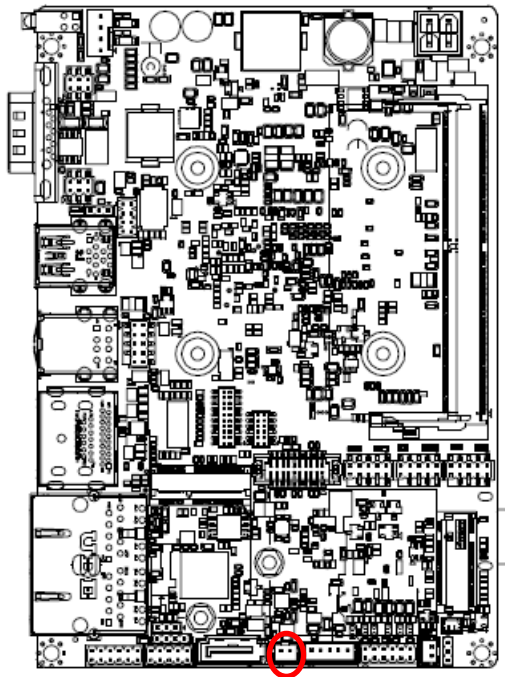

Signal	PIN
GND	1
+5V	2

2.3.12 Power connector (PWR1)

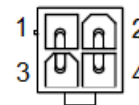
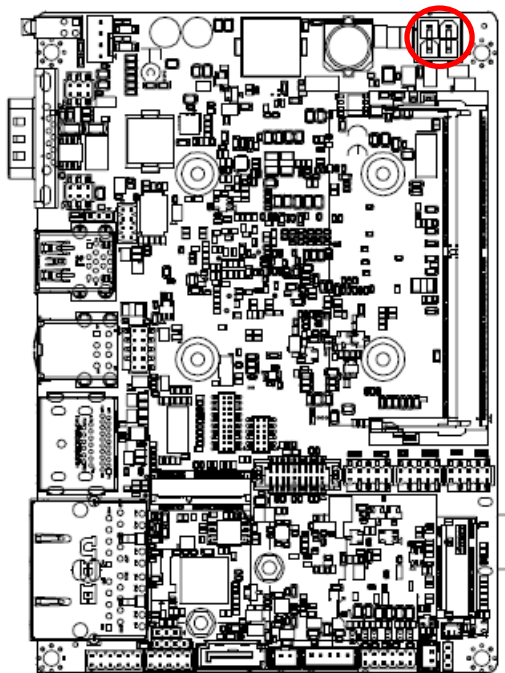

Signal	PIN	PIN	Signal
GND	1	2	GND
+VIN_EXT	3	4	+VIN_EXT

2.3.13 USB2.0 connector (JUSB1)

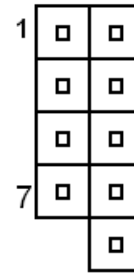
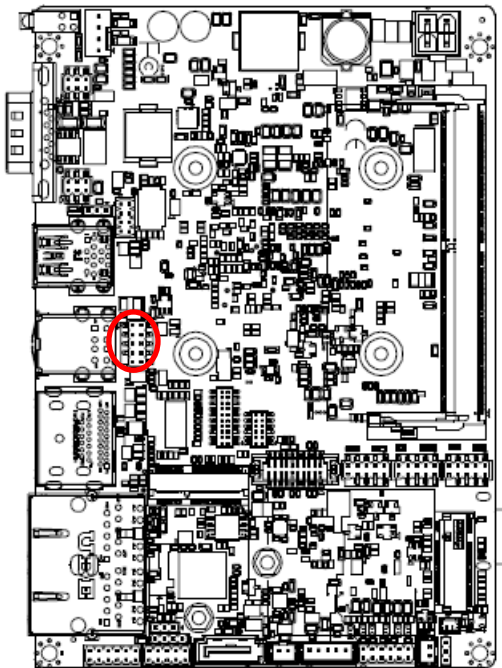

Signal	PIN	PIN	Signal
+5VSB	1	2	+5VSB
USB_R_DN4	3	4	USB_R_DN5
USB_R_DP4	5	6	USB_R_DP5
GND	7	8	GND
		10	GND

2.3.14 BIOS SPI connector (BIOS_SPI1)

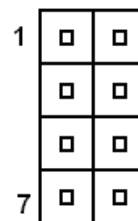
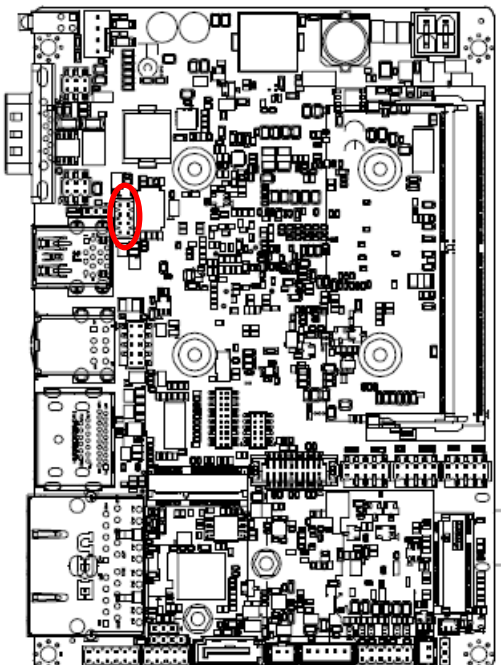

Signal	PIN	PIN	Signal
+3.3VSB	1	2	GND
SPI_CS0#	3	4	SPI_CLK
SPI_MISO	5	6	SPI_MOSI
BIOS_HOLD#	7	8	BIOS_WP#

2.3.15 EC Debug connector (JEC_ROM1)

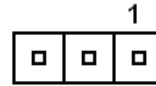
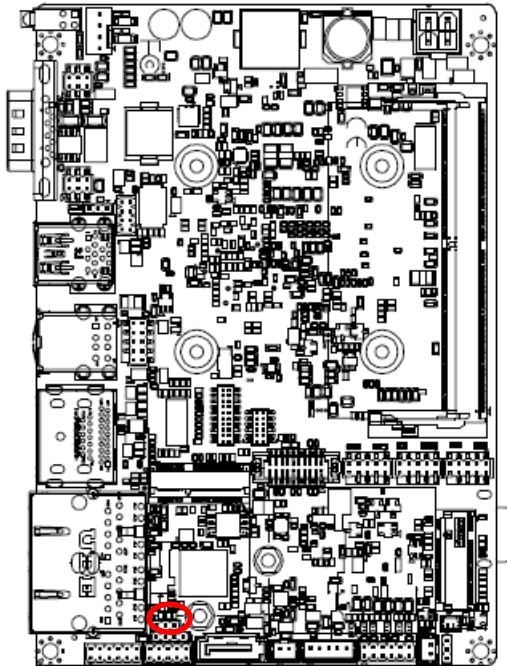

Signal	PIN
EC_SMCLK_DBG	1
EC_SMDAT_DBG	2
GND	3

2.3.16 Battery connector (BT1)

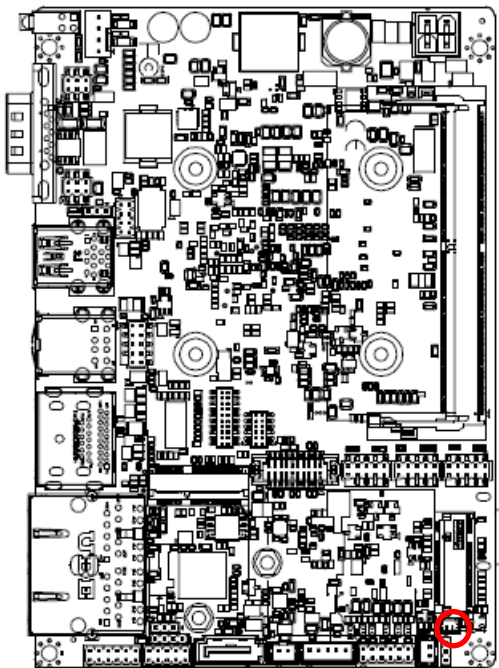

Signal	PIN
+RTCBATT	1
GND	2

2.3.17 Front Panel connector (JFP1)

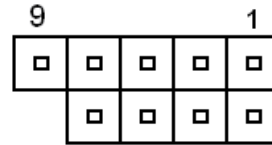
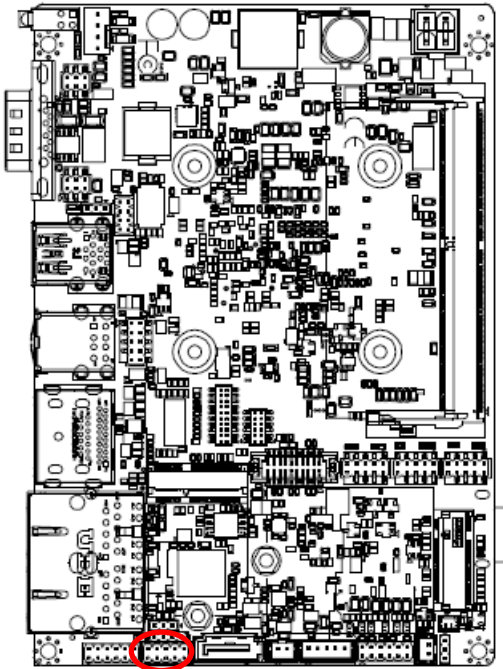

Signal	PIN	PIN	Signal
FP_HDD_LED+	1	2	FP_PWR_LED+
HDD_LED#	3	4	PWR_LED#
PMC_RSTBTN#	5	6	PWR_BTN_IN_EC#
GND	7	8	GND
NC	9		

2.3.18 PC Buzzer connector (JBZ1)

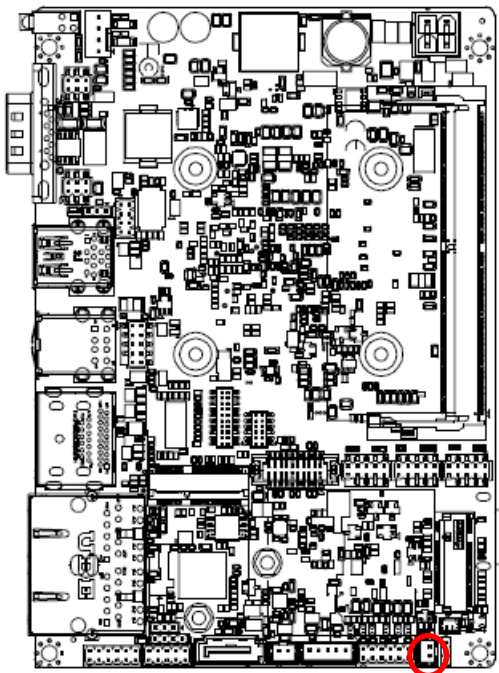

Signal	PIN
SOC_SPKR_R	1
+5V	2

2.3.19 Cortex Debug + ETM connector (JPSE1)

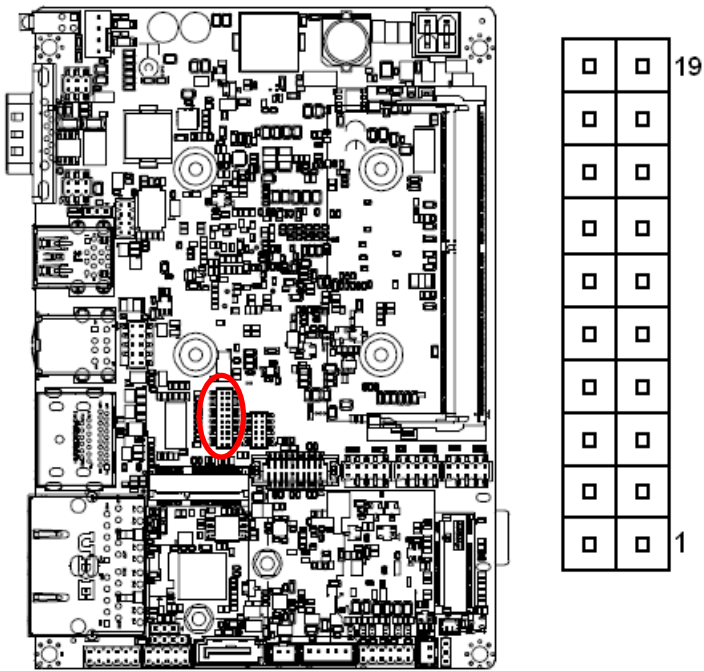

Signal	PIN	PIN	Signal
GND	20	19	PSE_TRACEDATA_3
GND	18	17	PSE_TRACEDATA_2
GND	16	15	PSE_TRACEDATA_1
TGTPWR_GND	14	13	PSE_TRACEDATA_0
TGTPWR_GND	12	11	PSE_TRACECLK
PSE_JTAG_GND_DET	10	9	PSE_JTAG_NRESET
NC	8	7	TP_TDI_PIN8
GND	6	5	PSE_TRACESWO
GND	4	3	PSE_SWCLK
+1.8VSB	2	1	PSE_SWDIO

2.3.20 Port80 connector (JESPI1)

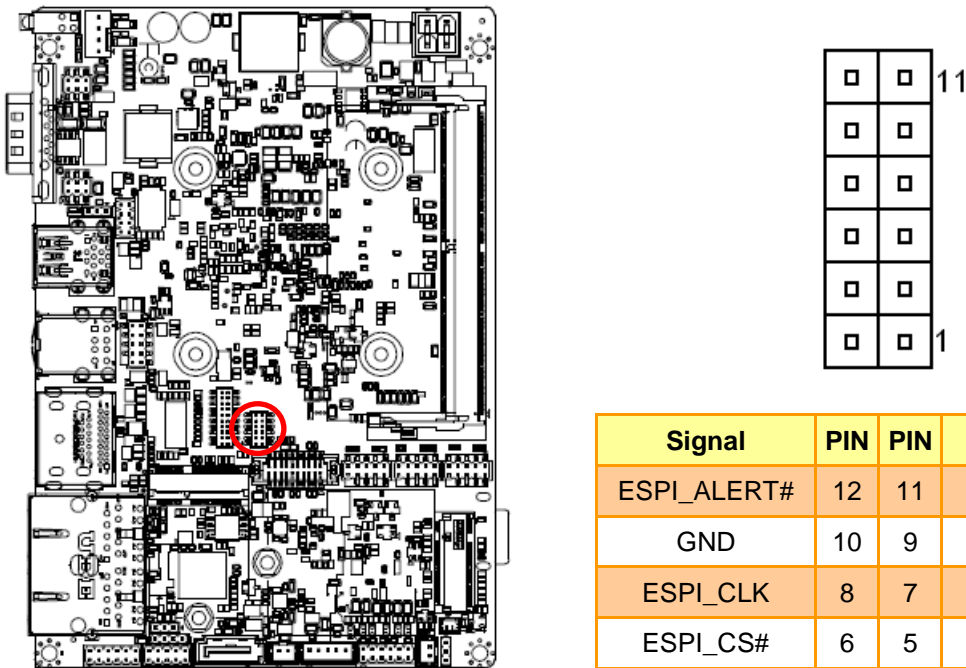

Signal	PIN	PIN	Signal
ESPI_ALERT#	12	11	ESPI_RST
GND	10	9	NC
ESPI_CLK	8	7	ESPI_IO3
ESPI_CS#	6	5	ESPI_IO2
PLT_RST_BUF#	4	3	ESPI_IO1
+3.3VSB	2	1	ESPI_IO0

2.3.21 eDP connector (JEDP1)

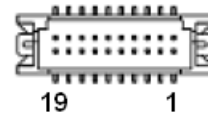
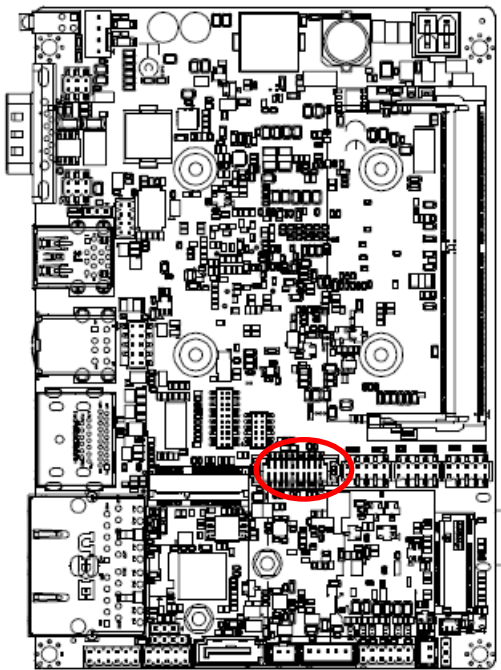

Signal	PIN	PIN	Signal
GND	1	2	GND
EDP_Panel_TXN0	3	4	EDP_Panel_TXN3
EDP_Panel_TXP0	5	6	EDP_Panel_TXP3
GND	7	8	NC
EDP_Panel_TXN1	9	10	GND
EDP_Panel_TXP1	11	12	EDP_Panel_AUXN
GND	13	14	EDP_Panel_AUXP
EDP_Panel_TXN2	15	16	GND
EDP_Panel_TXP2	17	18	SOC_DDI0_HPDP
+VeDP	19	20	+VeDP

2.3.22 Audio connector (JAUDIO1)

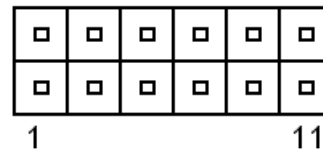
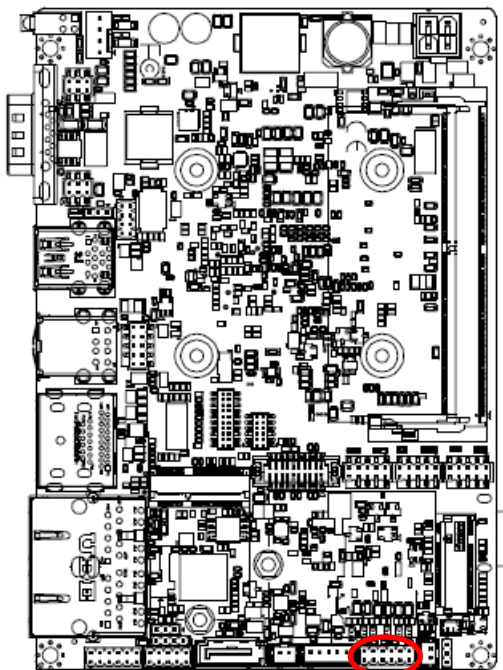

Signal	PIN	PIN	Signal
FRONT-R-OUT	1	2	FRONT-L-OUT
HD_AGND	3	4	HD_AGND
LINE1-R-IN	5	6	LINE1-L-IN
MIC1-R-IN	7	8	MIC1-L-IN
FRONT-JD	9	10	LINE1-JD
MIC1-JD	11	12	HD_AGND

2.3.22.1 Signal Description – Audio connector (JAUDIO1)

Signal	Signal Description
LINE1-JD	AUDIO IN (LINE_RIN/LIN)sense pin
FRONT-JD	AUDIO Out(ROUT/LOUT) sense pin
MIC1-JD	MIC IN (MIC_RIN/LIN) sense pin

3. BIOS Setup

3.1 Introduction

The BIOS setup program allows users to modify the basic system configuration. In this following chapter will describe how to access the BIOS setup program and the configuration options that may be changed.

3.2 Starting Setup

AMI BIOS™ is immediately activated when you first power on the computer. The BIOS reads the system information contained in the NVRAM and begins the process of checking out the system and configuring it. When it finishes, the BIOS will seek an operating system on one of the disks and then launch and turn control over to the operating system.

While the BIOS is in control, the Setup program can be activated in one of two ways:

By pressing <ESC> or immediately after switching the system on, or

By pressing the <ESC> or key when the following message appears briefly at the left-top of the screen during the POST (Power On Self Test).

Press <ESC> or to enter SETUP

If the message disappears before you respond and you still wish to enter Setup, restart the system to try again by turning it OFF then ON or pressing the "RESET" button on the system case. You may also restart by simultaneously pressing <Ctrl>, <Alt>, and <Delete> keys.

3.3 Using Setup

In general, you use the arrow keys to highlight items, press <Enter> to select, use the PageUp and PageDown keys to change entries, press <F1> for help and press <Esc> to quit. The following table provides more detail about how to navigate in the Setup program using the keyboard.

Button	Description
↑	Move to previous item
↓	Move to next item
←	Move to the item in the left hand
→	Move to the item in the right hand
Esc key	Main Menu -- Quit and not save changes into NVRAM Status Page Setup Menu and Option Page Setup Menu -- Exit current page and return to Main Menu
+ key	Increase the numeric value or make changes
- key	Decrease the numeric value or make changes
F1 key	General help, only for Status Page Setup Menu and Option Page Setup Menu
F2 key	Previous Values
F3 key	Optimized defaults
F4 key	Save & Exit Setup

- **Navigating Through The Menu Bar**

Use the left and right arrow keys to choose the menu you want to be in.



Note: Some of the navigation keys differ from one screen to another.

- **To Display a Sub Menu**

Use the arrow keys to move the cursor to the sub menu you want. Then press <Enter>. A “➤” pointer marks all sub menus.

3.4 Getting Help

Press F1 to pop up a small help window that describes the appropriate keys to use and the possible selections for the highlighted item. To exit the Help Window press <Esc> or the <Enter> key again.

3.5 In Case of Problems

If, after making and saving system changes with Setup, you discover that your computer no longer is able to boot, the AMI BIOS supports an override to the NVRAM settings which resets your system to its defaults.

The best advice is to only alter settings which you thoroughly understand. To this end, we strongly recommend that you avoid making any changes to the chipset defaults. These defaults have been carefully chosen by both BIOS Vendor and your systems manufacturer to provide the absolute maximum performance and reliability. Even a seemingly small change to the chipset setup has the potential for causing you to use the override.

3.6 BIOS setup

Once you enter the Aptio Setup Utility, the Main Menu will appear on the screen. The Main Menu allows you to select from several setup functions and exit choices. Use the arrow keys to select among the items and press <Enter> to accept and enter the sub-menu.

3.6.1 Main Menu

This section allows you to record some basic hardware configurations in your computer and set the system clock.

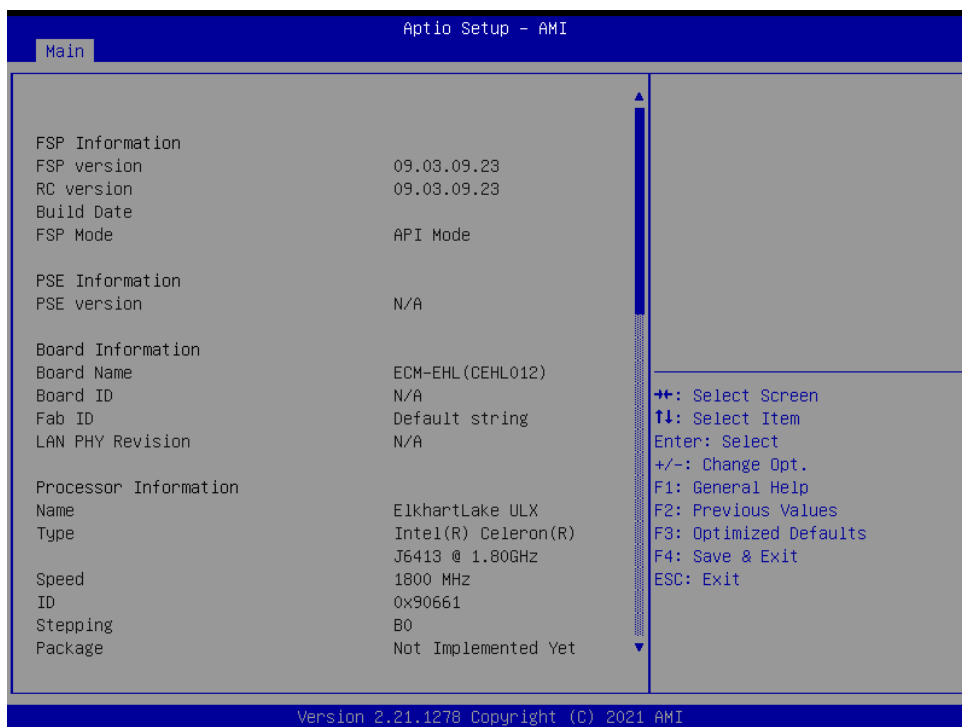

3.6.1.1 System Language

This option allows choosing the system default language.

3.6.1.2 System Date

Use the system date option to set the system date. Manually enter the day, month and year.

3.6.1.3 System Time

Use the system time option to set the system time. Manually enter the hours, minutes and seconds.



Note: The BIOS setup screens shown in this chapter are for reference purposes only, and may not exactly match what you see on your screen.

Visit the Avalue website (www.avalue.com.tw) to download the latest product and BIOS information.

3.6.2 Advanced Menu

This section allows you to configure your CPU and other system devices for basic operation through the following sub-menus.

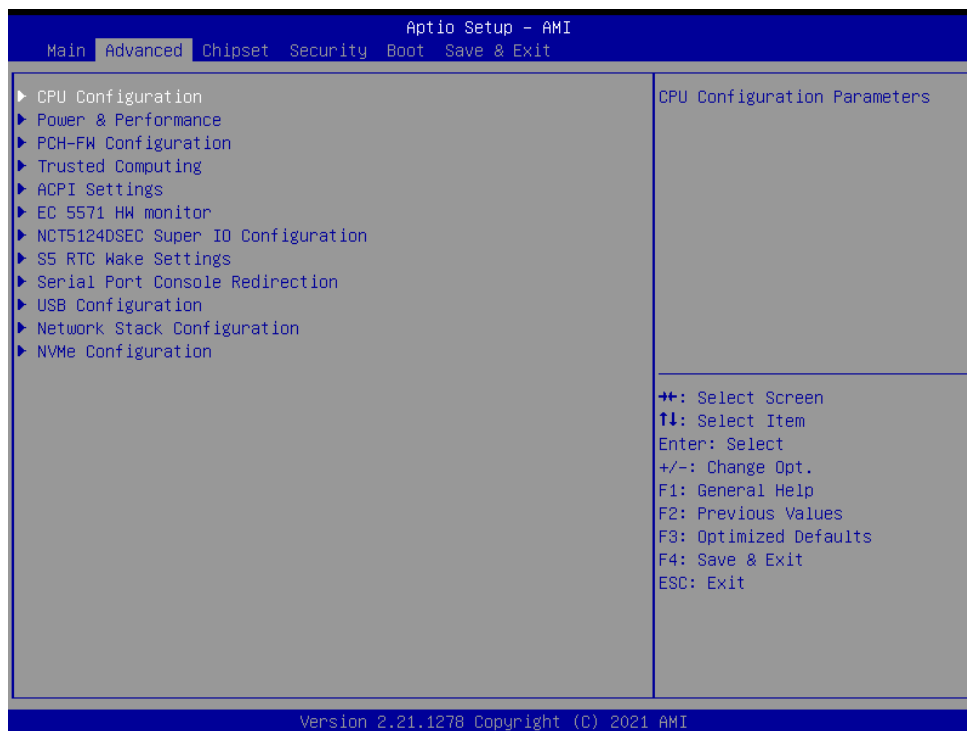

3.6.2.1 CPU Configuration

Use the CPU configuration menu to view detailed CPU specification and configure the CPU.

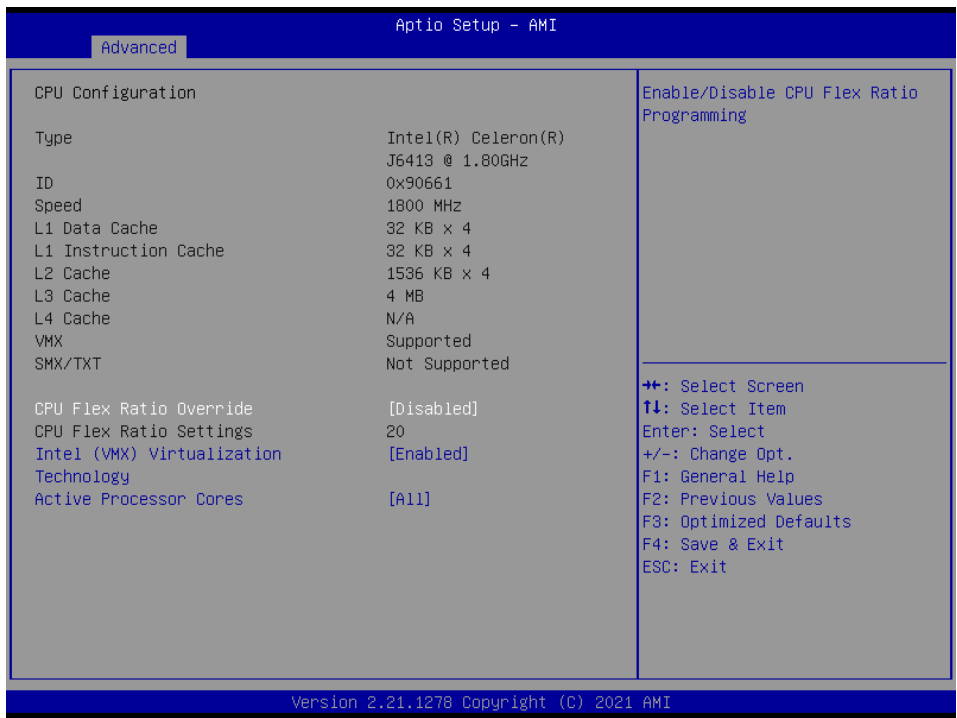

Item	Options	Description
CPU Flex Ratio Override	Disabled[Default] Enabled	Enable/Disable CPU Flex Ratio Programming.
Intel (VMX) Virtualization Technology	Disabled Enabled[Default]	When enabled, a VMM can utilize the additional hardware capabilities provided by Vanderpool Technology.
Active Processor Cores	All[Default] 1 2 3 4 5 6 7 8	Number of cores to enable in each processor package.

3.6.2.2 Power & Performance



3.6.2.2.1 CPU – Power Management Control

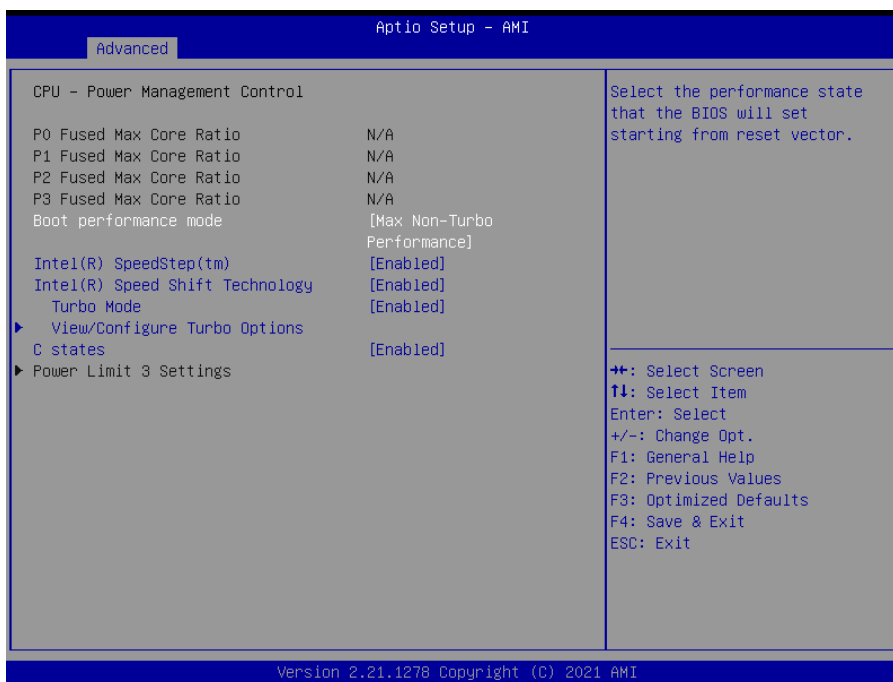

Item	Option	Description
Boot performance mode	Max Battery Max Non-Turbo Performance[Default], Turbo Performance	Select the performance state that the BIOS will set starting from reset vector.
Intel® SpeedStep™	Enabled[Default], Disabled	Allows more than two frequency ranges to be supported.

ECM-EHL User's Manual

Intel® Speed Shift Technology	Enabled[Default], Disabled	Enable/Disable Intel® Speed Shift Technology support. Enabling will expose the CPPC v2 interface to allow for hardware controlled P-states.
Turbo Mode	Enabled[Default], Disabled	Enable/Disable processor Turbo Mode (requires Intel Speed Step or Intel Speed Shift to be available and enabled).
C States	Enabled[Default], Disabled	Enable/Disable CPU Power Management. Allows CPU to go to C states when it's not 100% utilized.

3.6.2.2.1.1 View/Configure Turbo Options

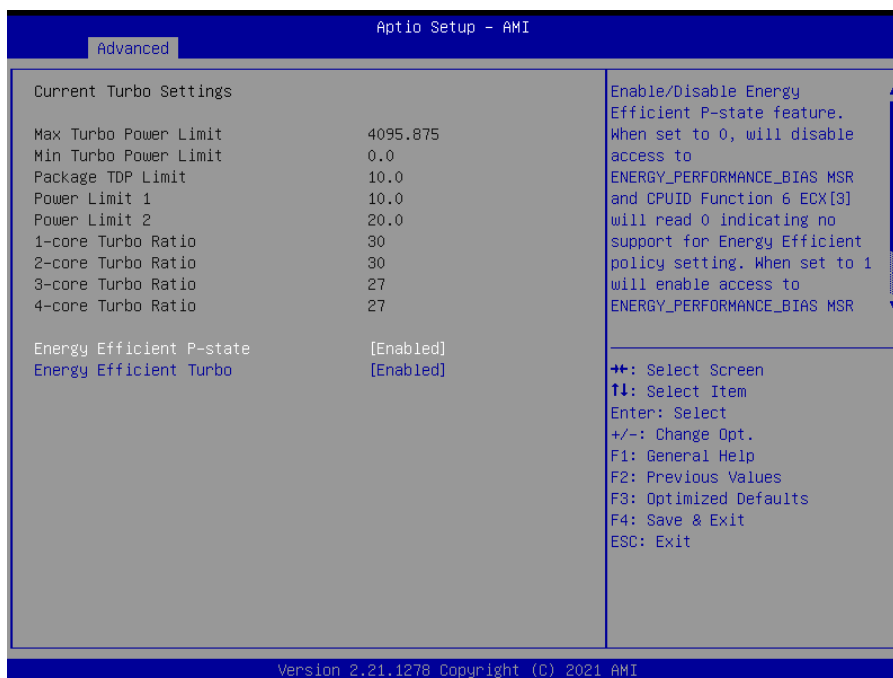

Item	Option	Description
Energy Efficient P-state	Disabled Enabled[Default]	Enable/Disable Energy Efficient P-state feature. When set to 0, will disable access to ENERGY_PERFORMANCE_BIAS MSR and CPUID Function 6 ECX[3] will read 0 indicating no support for Energy Efficient policy setting. When set to 1 will enable access to ENERGY_PERFORMANCE_BIAS MSR 1B0h.
Energy Efficient Turbo	Disabled Enabled[Default]	Enable/Disable Energy Efficient Turbo Feature. This feature will opportunistically lower the turbo frequency to increase efficiency. Recommended only to disable in overclocking situations where turbo frequency must remain constant. Otherwise, leave enabled.

3.6.2.2.2 GT – Power Management Control



Item	Option	Description
RC6(Render Standby)	Enabled[Default], Disabled	Check to enable render standby support.
Maximum GT frequency	Default Max Frequency[Default] 100Mhz/150Mhz/200Mhz/250Mhz/300Mhz /350Mhz/400Mhz/450Mhz/500Mhz/550Mhz /600Mhz/650Mhz/700Mhz/750Mhz/800Mhz /850Mhz/900Mhz/950Mhz/1000Mhz/1050Mhz /1100Mhz/1150Mhz/1200Mhz	Auto Updated.
Disable Turbo GT frequency	Enabled Disabled[Default]	Enabled: Disables Turbo GT frequency. Disabled: GT frequency is not limited.

3.6.2.3 PCH-FW Configuration



Item	Options	Description
ME Unconfig on RTC Clear	Disabled, Enabled[Default]	When Disabled ME will not be unconfigured on RTC Clear.

3.6.2.3.1 Firmware Update Configuration



Item	Option	Description
ME FW Image Re-Flash	Disabled [Default], Enabled	Enable/Disable Me FW Image Re-Flash function.

3.6.2.3.2 PTT Configuration

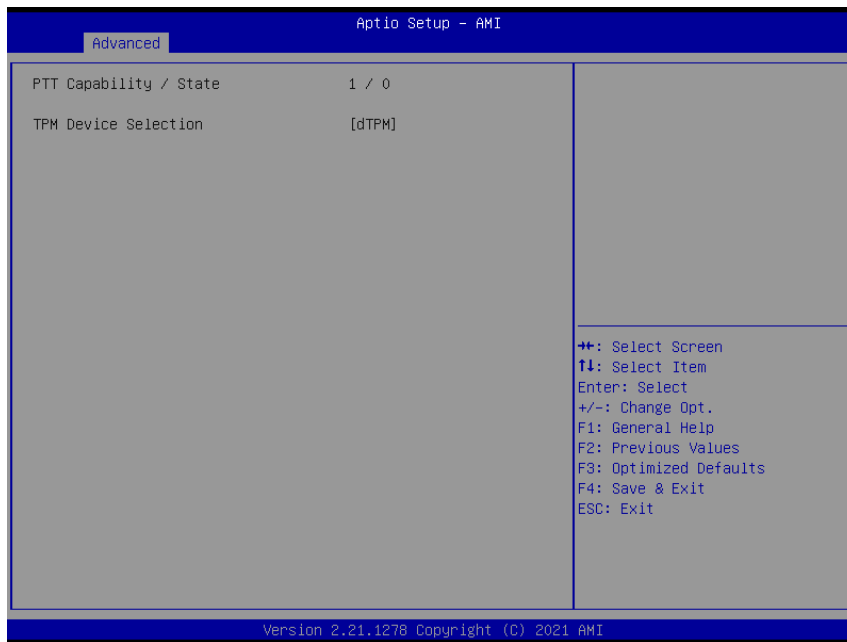

3.6.2.4 Trusted Computing



Item	Options	Description
Security Device Support	Disable, Enable[Default]	Enables or Disables BIOS support for security device. O.S. will not show Security Device. TCG EFI protocol and INT1A interface will not be available.

ECM-EHL User's Manual

3.6.2.5 APCI Settings

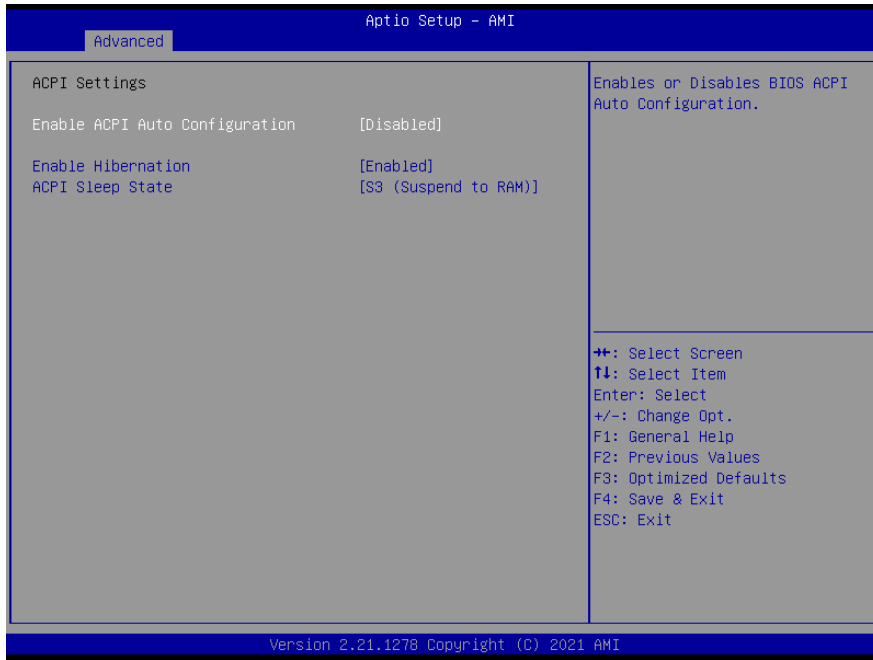

Item	Options	Description
Enable ACPI Auto Configuration	Disabled[Default], Enabled	Enables or Disables BIOS ACPI Auto Configuration.
Enable Hibernation	Disabled Enabled[Default],	Enables or Disables System ability to Hibernate (OS/S4 Sleep State). This option may not be effective with some OS.
ACPI Sleep State	Suspend Disabled, S3 (Suspend to RAM)[Default]	Select the highest ACPI sleep state the system will enter when the SUSPEND button is pressed.

3.6.2.6 HW Monitor

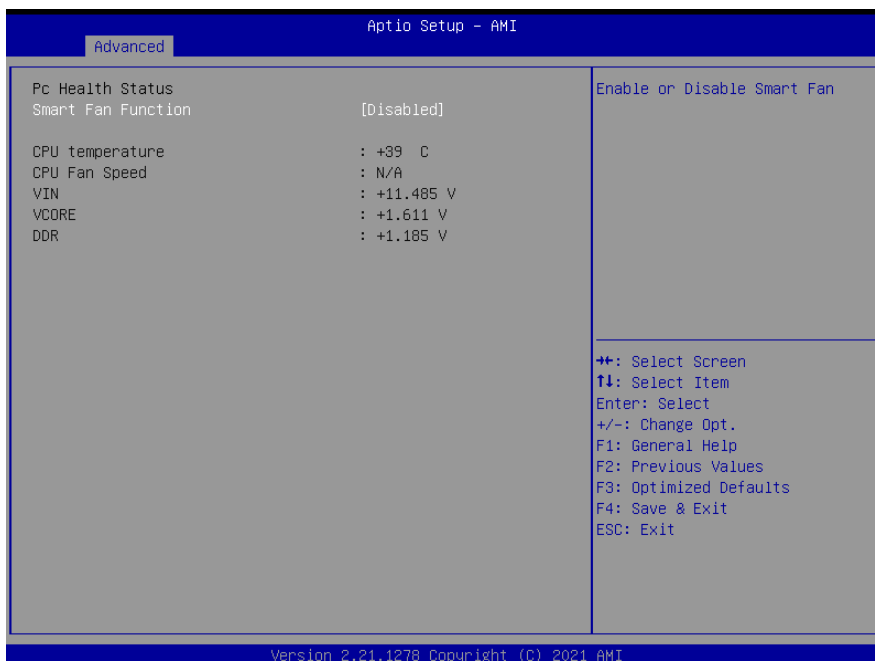

Item	Options	Description
Smart Fan Function	Enabled, Disabled[Default]	Enables or Disables Smart Fan.

3.6.2.7 NCT5124DSEC Super IO Configuration

You can use this item to set up or change the NCT5124DSEC Super IO configuration for serial ports. Please refer to 3.6.2.7.1 for more information.

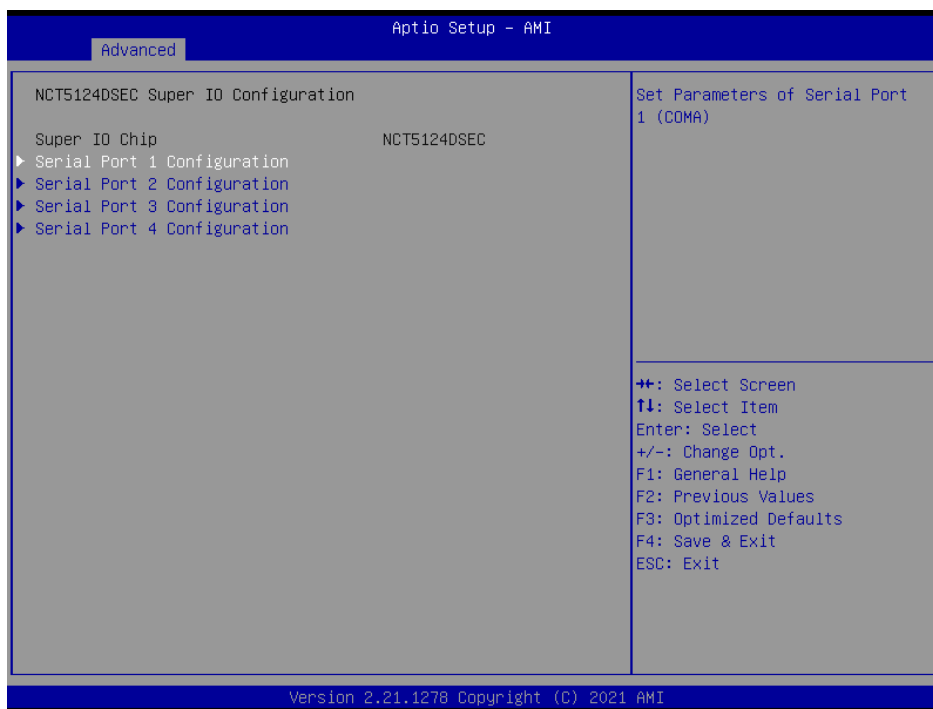

Item	Description
Serial Port 1 Configuration	Set Parameters of Serial Port 1 (COMA).
Serial Port 2 Configuration	Set Parameters of Serial Port 2 (COMB).
Serial Port 3 Configuration	Set Parameters of Serial Port 3 (COMC).
Serial Port 4 Configuration	Set Parameters of Serial Port 4 (COMD).

3.6.2.7.1 Serial Port 1 Configuration

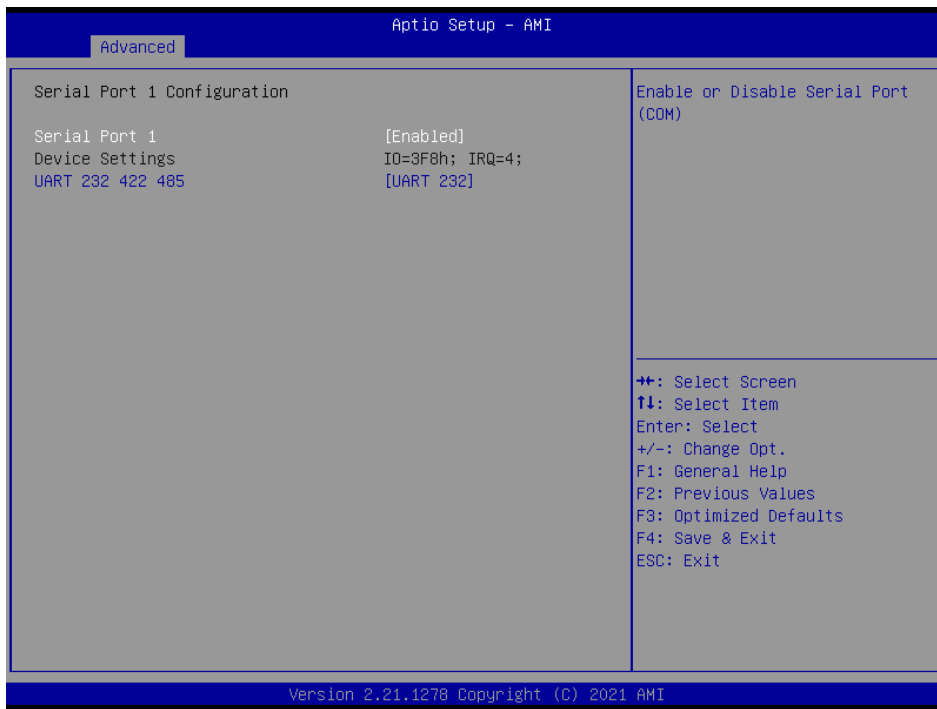

Item	Option	Description
Serial Port 1	Enabled[Default], Disabled	Enable or Disable Serial Port (COM).
UART 232 422 485	UART 232[Default], UART 422 UART 485	Change the Serial Port as RS232/422/485.

3.6.2.7.2 Serial Port 2 Configuration



Item	Option	Description
Serial Port 2	Enabled[Default], Disabled	Enable or Disable Serial Port (COM).

3.6.2.7.3 Serial Port 3 Configuration

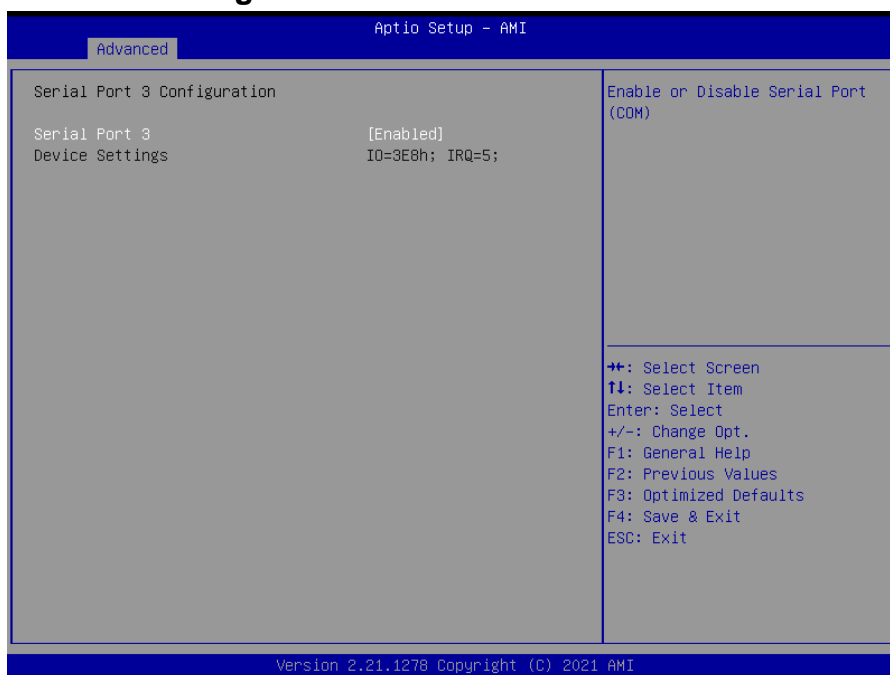

Item	Option	Description
Serial Port 3	Enabled[Default], Disabled	Enable or Disable Serial Port (COM).

3.6.2.7.4 Serial Port 4 Configuration

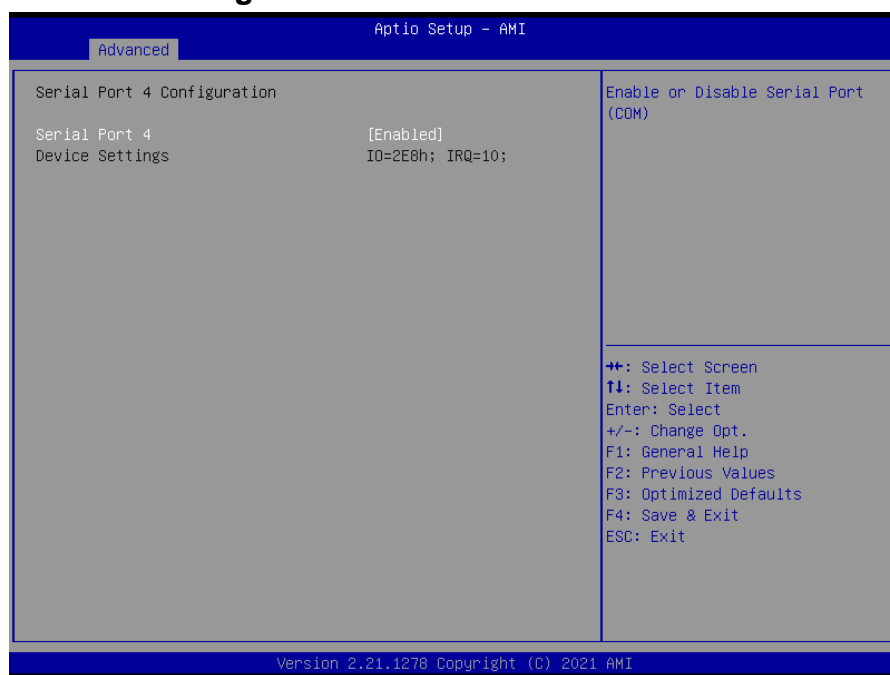

Item	Option	Description
Serial Port 4	Enabled[Default], Disabled	Enable or Disable Serial Port (COM).

3.6.2.8 S5 RTC Wake Settings



Item	Options	Description
Wake system from S5	Disabled[Default], Fixed Time Dynamic Time	Enable or disable System wake on alarm event. Select Fixed Time, system will wake on the hr::min::sec specified. Select Dynamic Time, System will wake on the current time + Increase minute(s).

3.6.2.9 Serial Port Console Redirection

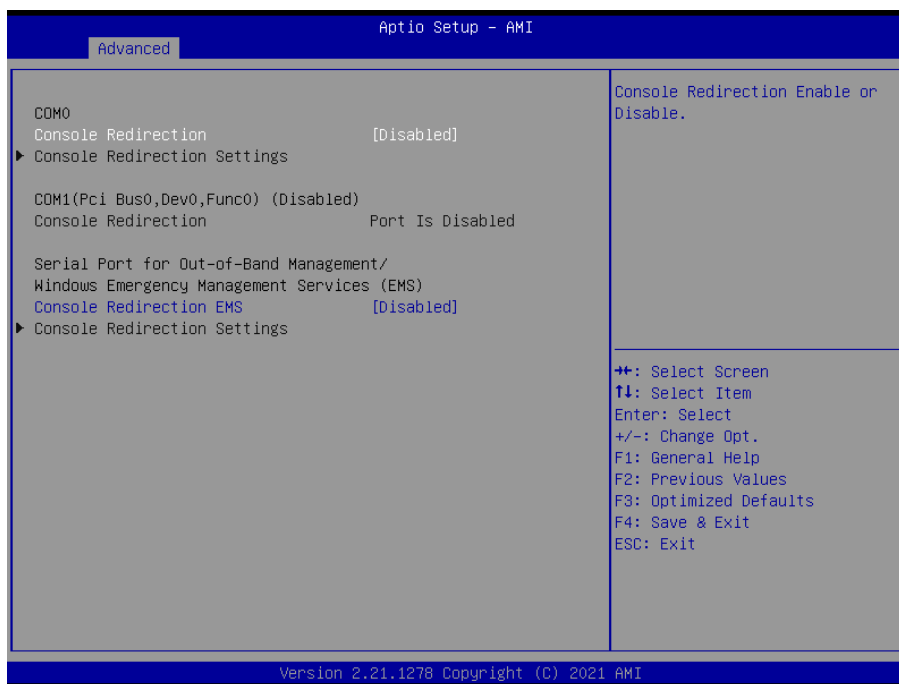

Item	Options	Description
Console Redirection	Disabled[Default], Enabled	Console Redirection Enable or Disable.
Console Redirection EMS	Disabled[Default], Enabled	Console Redirection Enable or Disable.

3.6.2.10 USB Configuration

The USB Configuration menu helps read USB information and configures USB settings.

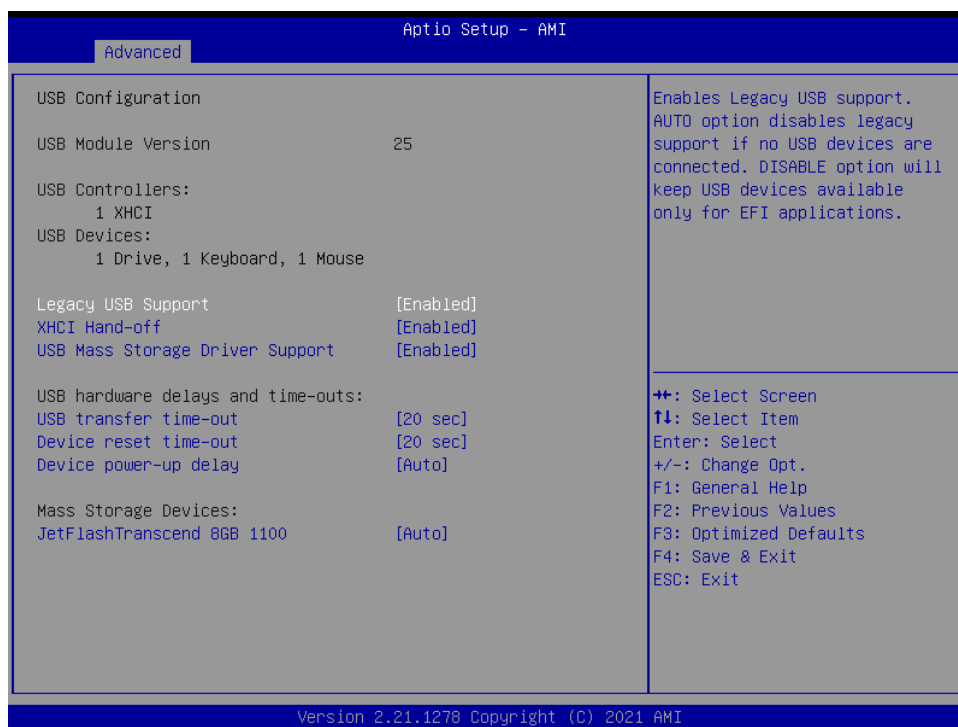

Item	Options	Description
Legacy USB Support	Enabled[Default], Disabled Auto	Enables Legacy USB support. AUTO option disables legacy support if no USB devices are connected. DISABLE option will keep USB devices available only for EFI applications.
XHCI Hand-off	Enabled[Default], Disabled	This is a workaround for OSeS without XHCI hand-off support. The XHCI ownership change should be claimed by XHCI driver.
USB Mass Storage Driver Support	Disabled Enabled[Default],	Enable/Disable USB Mass Storage Driver Support.
USB transfer time-out	1 sec 5 sec 10 sec 20 sec[Default]	The time-out value for Control, Bulk, and Interrupt transfers.
Device reset time-out	10 sec 20 sec[Default] 30 sec 40 sec	USB mass storage device Start Unit command time-out.
Device power-up delay	Auto[Default]	Maximum time the device will take before it

ECM-EHL User's Manual

	Manual	properly reports itself to the Host Controller. 'Auto' uses default value: for a Root port it is 100ms, for a Hub port the delay is taken form Hub descriptor.
Mass Storage Devices	Auto[Default] Floppy Forced FDD Hard Disk CD-ROM	Mass storage device emulation type. 'AUTO' enumerates devices according to their media format. Optical drives are emulated as 'CDROM', drives with no media will be emulated according to a drive type.

3.6.2.11 Network Stack Configuration

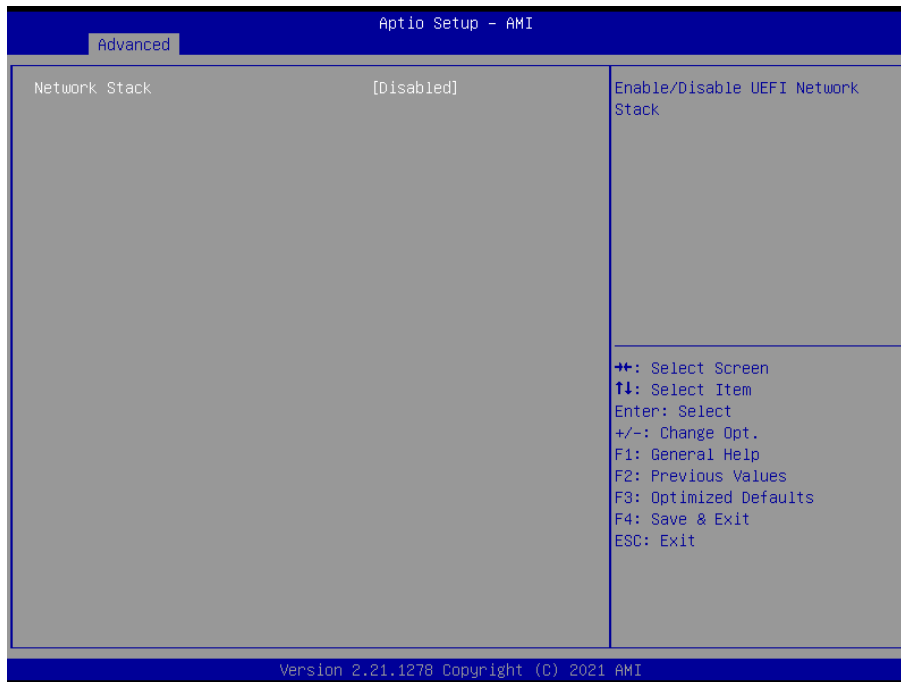

Item	Options	Description
Network Stack	Enabled Disabled[Default]	Enable/Disable UEFI Network Stack.

3.6.2.12 NVMe Configuration

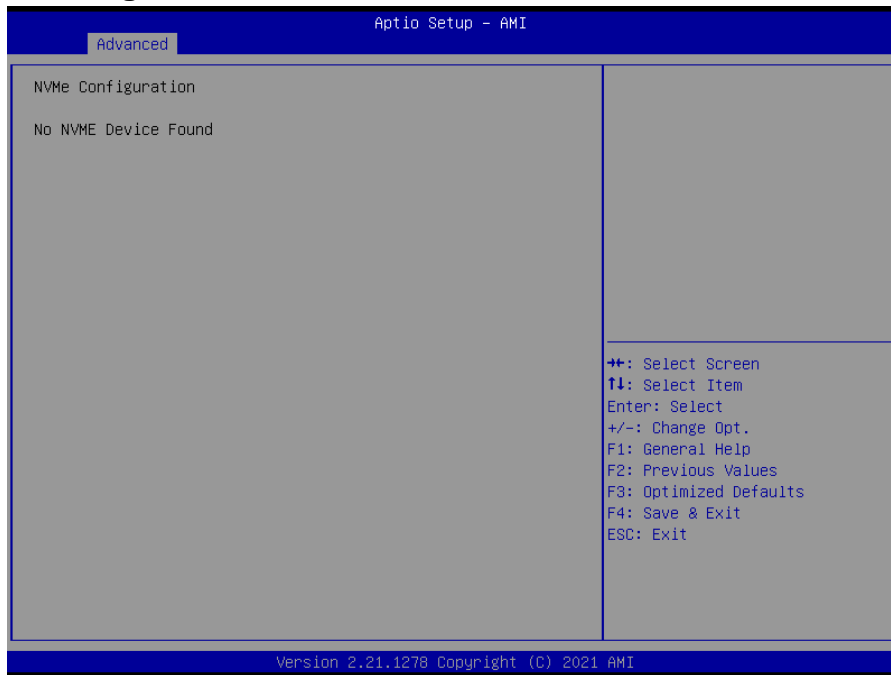

3.6.3 Chipset



3.6.3.1 System Agent (SA) Configuration



Item	Option	Description
VT-d	Enabled[Default] Disabled	VT-d capability.
Above 4GB MMIO BIOS assignment	Enabled Disabled[Default]	Enable/Disable above 4GB MemoryMappedIO BIOS assignment. This is enabled automatically when Aperture Size is set to 2048MB.

3.6.3.1.1 Memory Configuration

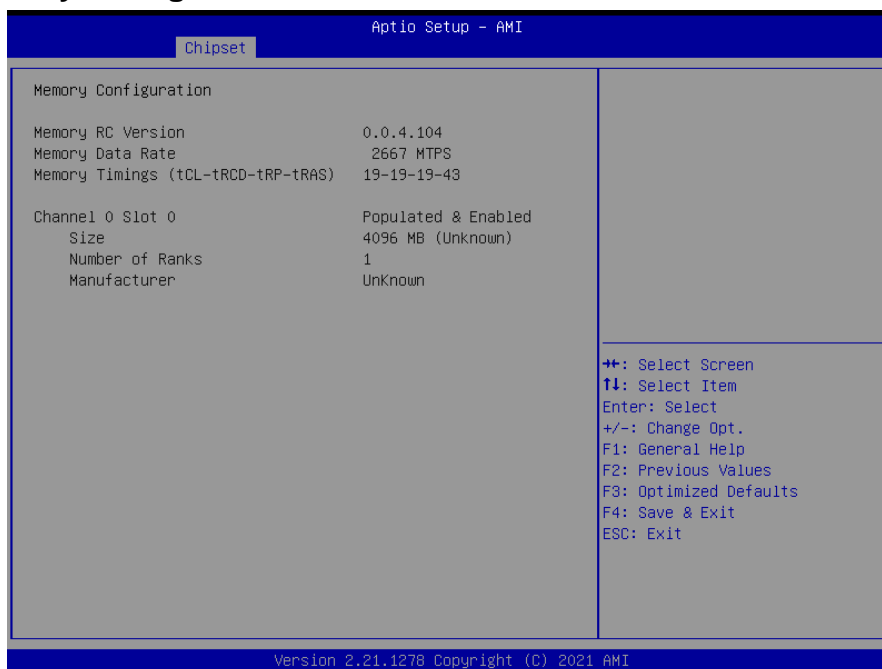

3.6.3.1.2 Graphics Configuration

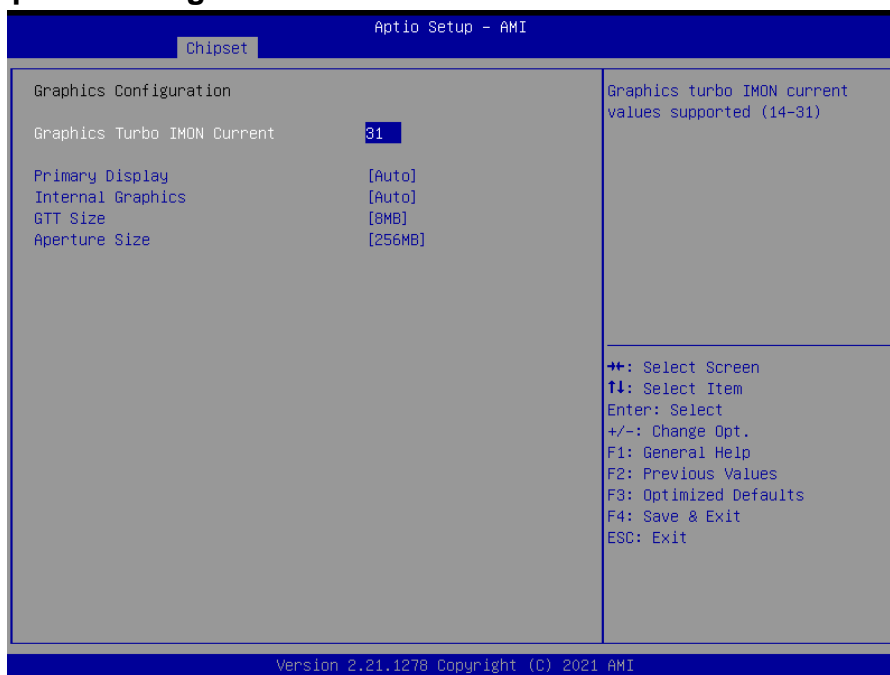

Item	Option	Description
Graphics Turbo IMON Current	14-31 [Default]	Graphics turbo IMON current values supported (14-31).
Primary Display	Auto [Default] IGFX PEG PCI	Select which of IGFX/PEG/PCI Graphics device should be Primary Display Or select SG for Switchable Gfx.
Internal Graphics	Auto [Default] Disabled Enabled	Keep IGFX enabled based on the setup options.
GTT Size	2MB 4MB 8MB [Default]	Select the GTT Size.
Aperture Size	128MB 256MB [Default] 512MB 1024MB	Select the Aperture Size. Note: Above 4GB MMIO BIOS assignment is automatically enabled when selecting 2048MB aperture. To use this feature, please disable CSM Support.

3.6.3.2 PCH-IO Configuration



3.6.3.2.1 PCI Express Configuration

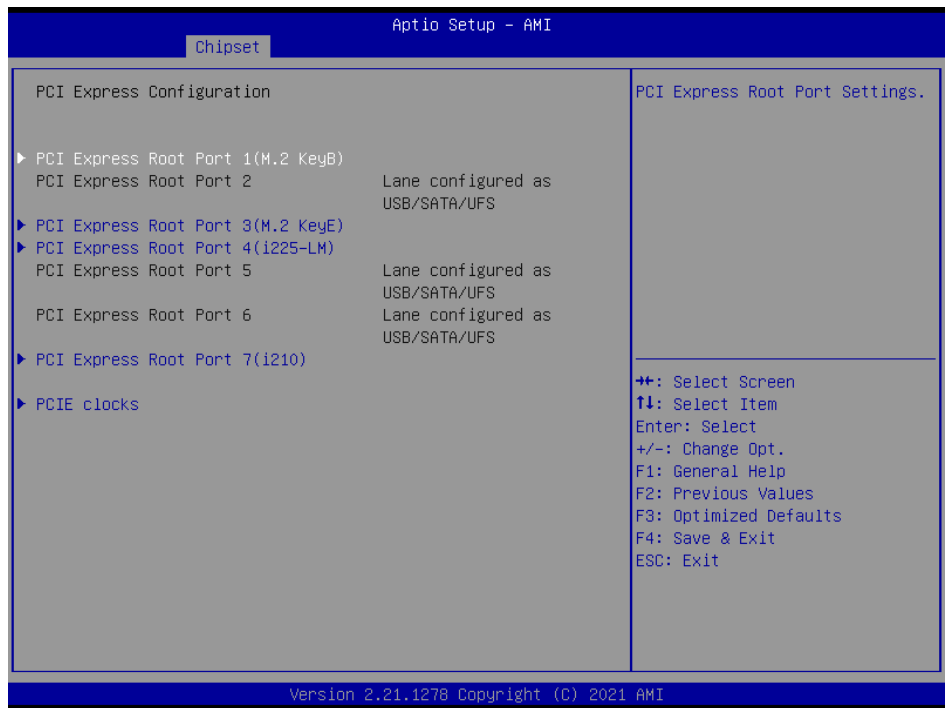

3.6.3.2.1.1 PCI Express Root Port 1(M.2 KeyB)

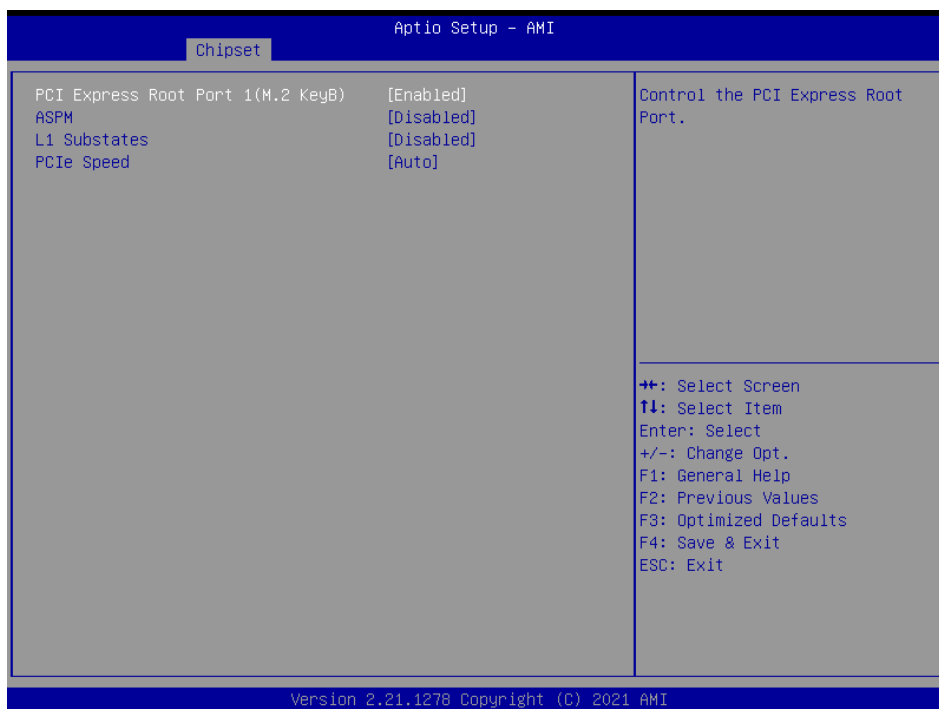

Item	Option	Description
PCI Express Root Port 1(M.2 KeyB)	Enabled[Default], Disabled	Control the PCI Express Root Port.
ASPM	Disabled[Default], L0s L1 L0sL1 Auto	Set the ASPM Level: Force L0s – Force all links to L0s State AUTO – BIOS auto configure DISABLE – Disables ASPM.
L1 Substates	Disabled[Default] L1.1 L1.1 & L1.2	PCI Express L1 Substates settings.
PCIe Speed	Auto[Default] Gen1 Gen2 Gen3	Configure PCIe Speed.

3.6.3.2.1.2 PCI Express Root Port 3(M.2 KeyE)

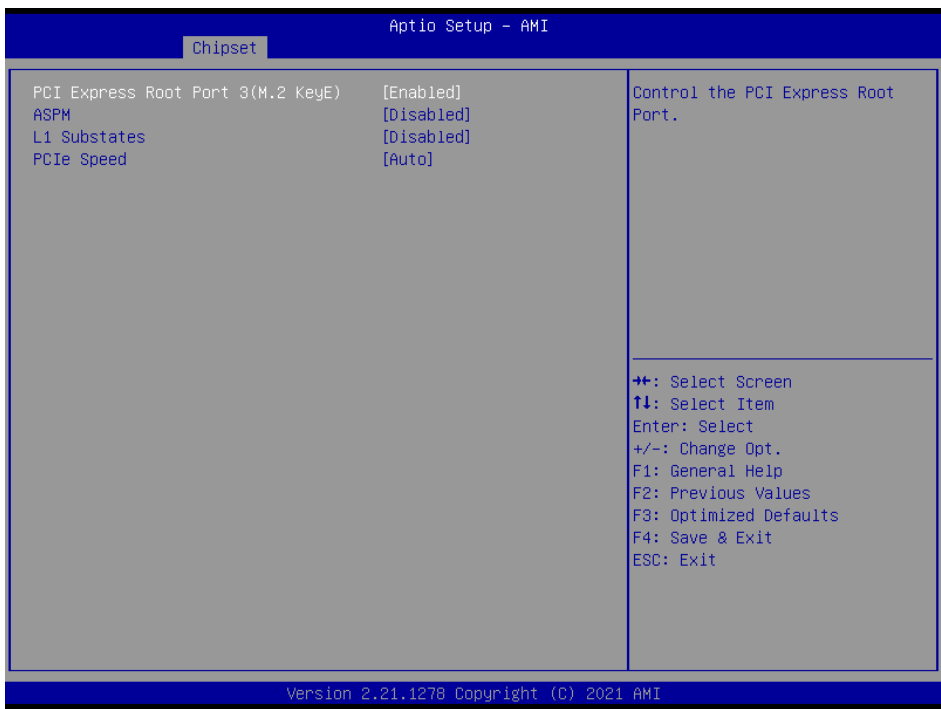

Item	Option	Description
PCI Express Root Port 3(M.2 KeyE)	Enabled[Default], Disabled	Control the PCI Express Root Port.
ASPM	Disabled[Default], L0s L1 L0sL1 Auto	Set the ASPM Level: Force L0s – Force all links to L0s State AUTO – BIOS auto configure DISABLE – Disables ASPM.
L1 Substates	Disabled[Default] L1.1 L1.1 & L1.2	PCI Express L1 Substates settings.
PCIe Speed	Auto[Default] Gen1 Gen2 Gen3	Configure PCIe Speed.

3.6.3.2.1.3 PCI Express Root Port 4(i225-LM)

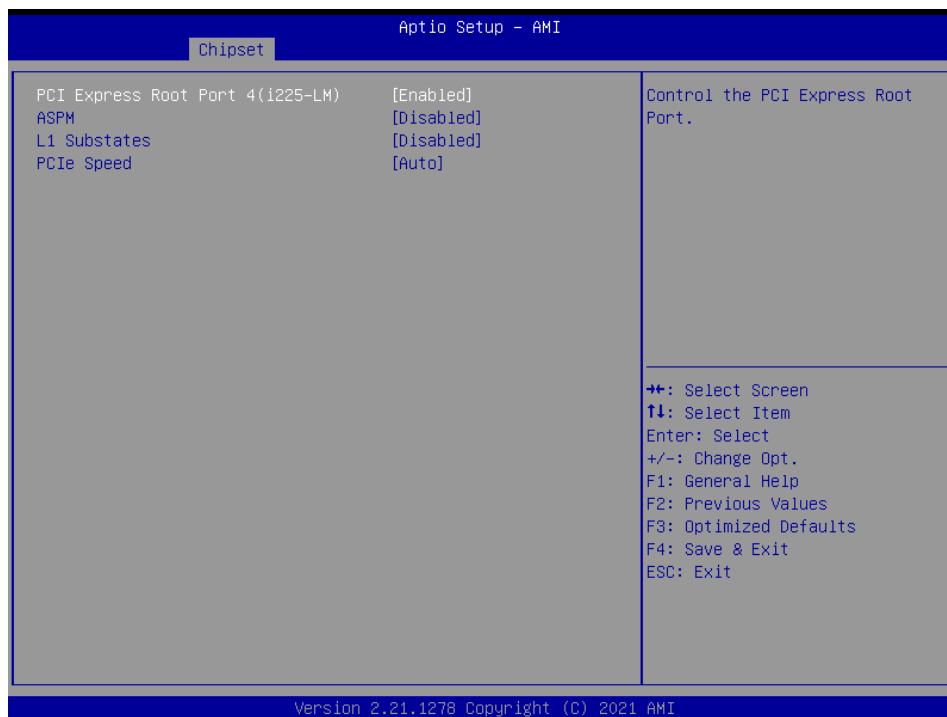

Item	Option	Description
PCI Express Root Port 4(i225-LM)	Enabled[Default], Disabled	Control the PCI Express Root Port.
ASPM	Disabled[Default], L0s L1 L0sL1 Auto	Set the ASPM Level: Force L0s – Force all links to L0s State AUTO – BIOS auto configure DISABLE – Disables ASPM.
L1 Substates	Disabled[Default], L1.1 L1.1 & L1.2	PCI Express L1 Substates settings.
PCIe Speed	Auto[Default] Gen1 Gen2 Gen3	Configure PCIe Speed.

3.6.3.2.1.4 PCI Express Root Port 7(i210)

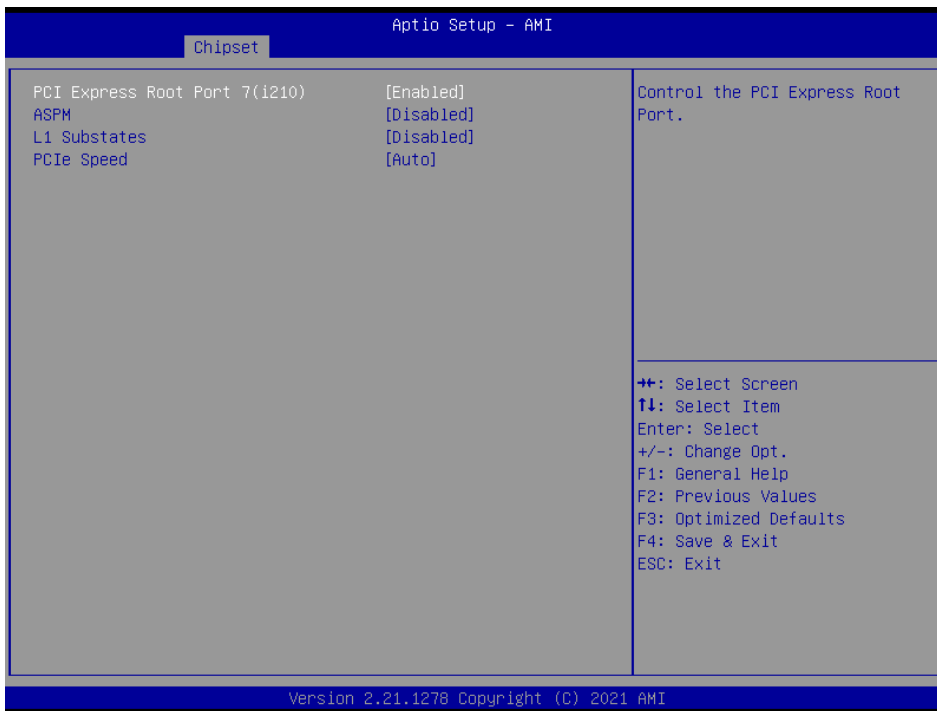

Item	Option	Description
PCI Express Root Port 7(i210)	Enabled[Default], Disabled	Control the PCI Express Root Port.
ASPM	Disabled[Default], L0s L1 L0sL1 Auto	Set the ASPM Level: Force L0s – Force all links to L0s State AUTO – BIOS auto configure DISABLE – Disables ASPM.
L1 Substates	Disabled[Default], L1.1 L1.1 & L1.2	PCI Express L1 Substates settings.
PCIe Speed	Auto[Default] Gen1 Gen2 Gen3	Configure PCIe Speed.

3.6.3.2.1.5 PCIE clocks

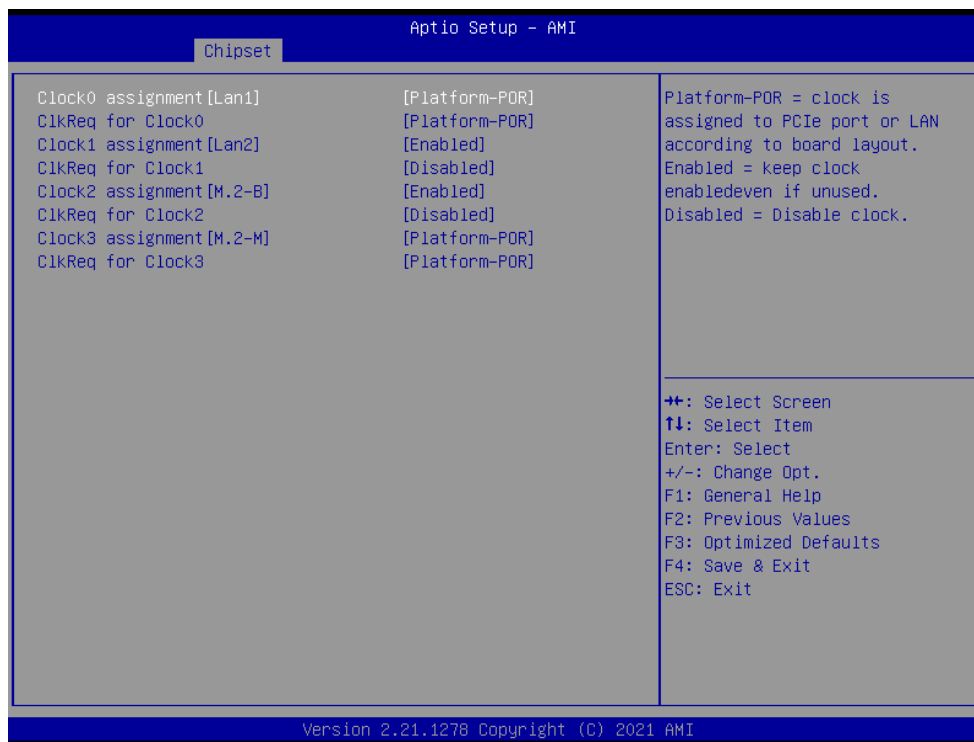

Item	Option	Description
Clock0 assignment[Lan1]	Platform-POR[Default], Enabled Disabled	Platform-POR= clock is assigned to PCIe port or LAN according to board layout. Enabled= keep clock enabled even if unused. Disabled = Disable clock.
ClkReq for Clock0	Platform-POR[Default], Disabled	Platform-POR= CLKREQ signal is assigned to CLKSRC according to board layout. Disabled = CLKREQ will not be used.
Clock1 assignment[Lan2]	Platform-POR Enabled[Default], Disabled	Platform-POR= clock is assigned to PCIe port or LAN according to board layout. Enabled= keep clock enabled even if unused. Disabled = Disable clock.
ClkReq for Clock1	Platform-POR, Disabled[Default]	Platform-POR= CLKREQ signal is assigned to CLKSRC according to board layout. Disabled = CLKREQ will not be used.
Clock2 assignment[M.2-B]	Platform-POR Enabled[Default] Disabled	Platform-POR= clock is assigned to PCIe port or LAN according to board layout. Enabled= keep clock enabled even if unused. Disabled = Disable clock.
ClkReq for Clock2	Platform-POR, Disabled[Default]	Platform-POR= CLKREQ signal is assigned to CLKSRC according to board layout. Disabled = CLKREQ will not be used.
Clock3 assignment[M.2-M]	Platform-POR[Default], Enabled Disabled	Platform-POR= clock is assigned to PCIe port or LAN according to board layout. Enabled= keep clock enabled even if unused. Disabled = Disable clock.

ClkReq for Clock3	Platform-POR[Default], Disabled	Platform-POR= CLKREQ signal is assigned to CLKSRC according to board layout. Disabled = CLKREQ will not be used.
--------------------------	---	---

3.6.3.2.2 SATA Configuration

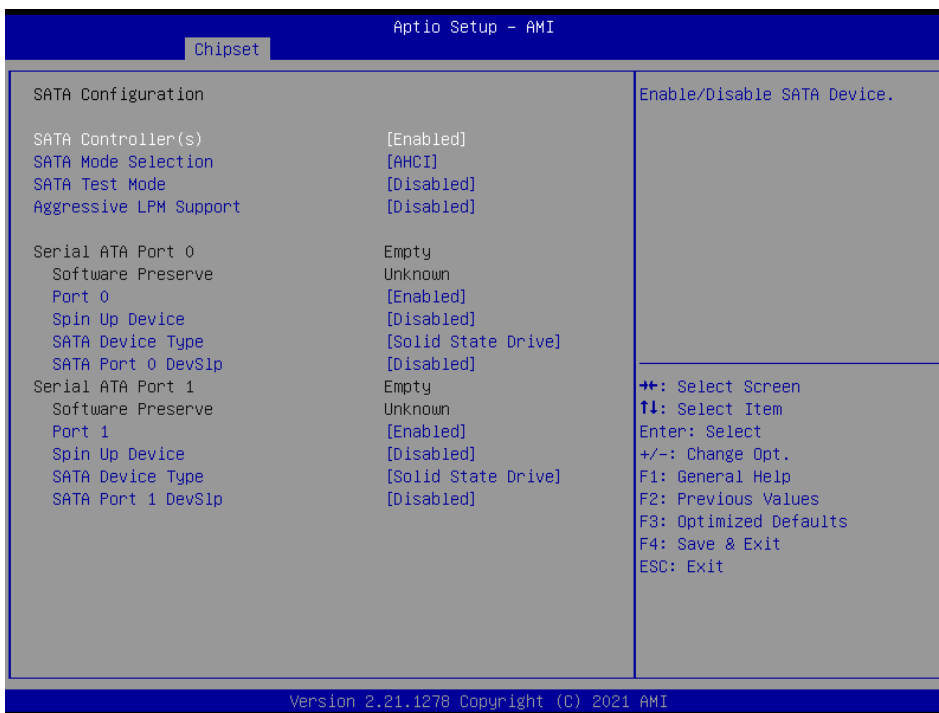

Item	Options	Description
SATA Controller(s)	Enabled[Default] Disabled,	Enable/Disable SATA Device.
SATA Mode Selection	AHCI[Default],	Determines how SATA controller(s) operate.
SATA Test Mode	Enabled Disabled[Default]	Test Mode Enable/Disable (Loop Back).
Aggressive LPM Support	Enabled Disabled[Default]	Enable PCH to aggressively enter link power state.
Port 0	Enabled[Default] Disabled	Enable or Disable SATA Port.
Spin Up Device	Enabled Disabled[Default]	If enabled for any of ports Staggered Spin Up will be performed and only the drives which have this option enabled will spin up at boot. Otherwise all drives spin up at boot.
SATA Device Type	Hard Disk Drive Solid State Drive[Default]	Identify the SATA port is connected to Solid State Drive or Hard Disk Drive.
SATA Port 0 DevSlp	Disabled[Default] Enabled	Enable/Disable SATA Port 0 DevSlp. For DevSlp to work, both hard drive and SATA port need to support DevSlp function, otherwise an unexpected behaviour might happen. Please check board design before enabling it.

Port 1	Enabled[Default] Disabled	Enable or Disable SATA Port.
Spin Up Device	Enabled Disabled[Default]	If enabled for any of ports Staggered Spin Up will be performed and only the drives which have this option enabled will spin up at boot. Otherwise all drives spin up at boot.
SATA Device Type	Hard Disk Drive Solid State Drive[Default]	Identify the SATA port is connected to Solid State Drive or Hard Disk Drive.
SATA Port 1 DevSlp	Disabled[Default] Enabled	Enable/Disable SATA Port 1 DevSlp. For DevSlp to work, both hard drive and SATA port need to support DevSlp function, otherwise an unexpected behaviour might happen. Please check board design before enabling it.

3.6.3.2.3 USB Configuration

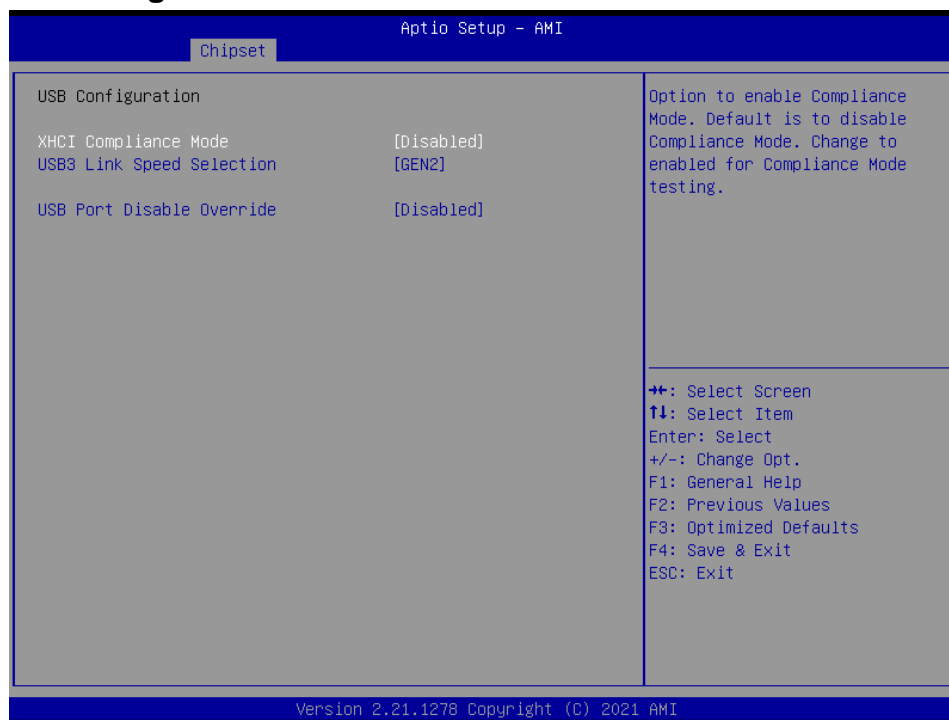

Item	Options	Description
XHCI Compliance Mode	Disabled[Default] Enabled	Option to enable Compliance Mode. Default is to disable Compliance Mode. Change to enabled for Compliance Mode testing.
USB3 Link Speed Selection	GEN1 GEN2[Default],	This option is to select USB3 Link Speed GEN1 or GEN2.
USB Port Disable Override	Disabled[Default] Select-Per-Pin	Selectively Enable/Disable the corresponding USB port from reporting a Device Connection to the controller.

3.6.3.2.4 HD Audio Configuration

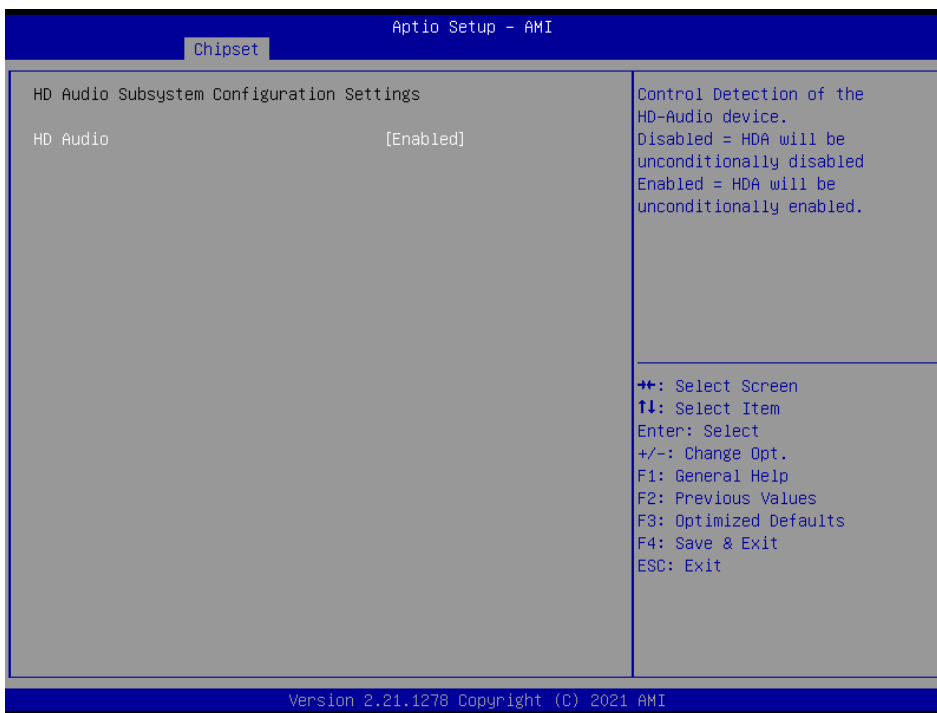

Item	Option	Description
HD Audio	Disabled Enabled[Default]	Control Detection of the HD-Audio device. Disable = HDA will be unconditionally disabled Enabled = HDA will be unconditionally enabled.

3.6.3.3 Board & Panel Configuration

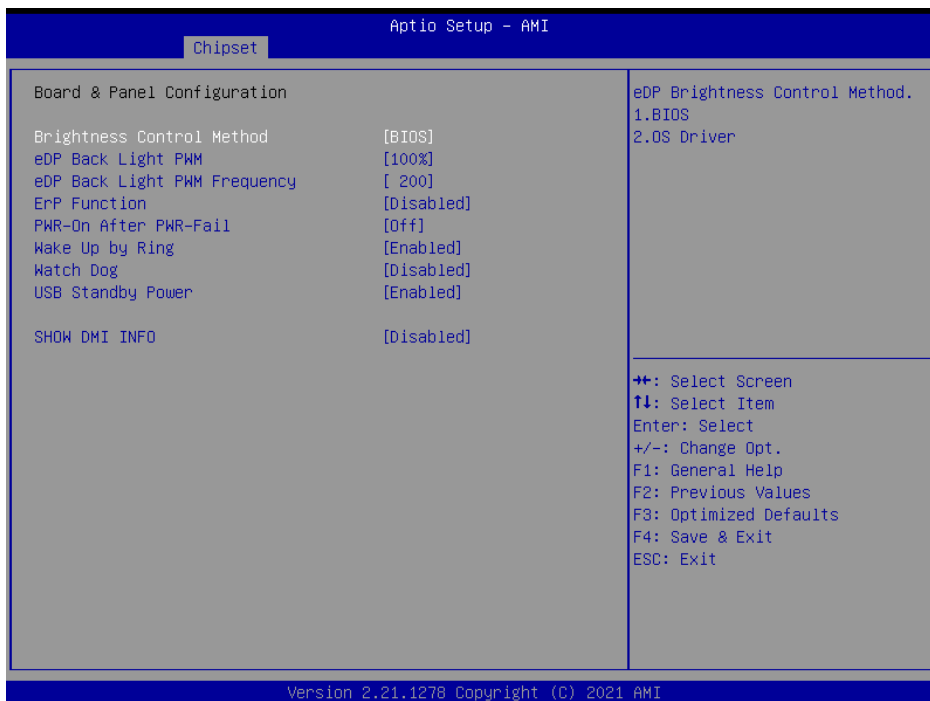

Item	Option	Description
Brightness Control Method	BIOS[Default] OS Driver	eDP Brightness Control Method. 1.BIOS 2.OS Driver.
eDP Back Light PWM	00% 25% 50% 75% 100%[Default]	Select eDP back light PWM duty.
eDP Back Light PWM Frequency	200[Default] 300 400 500 700 1k 2k 3k 5k 10k 20k	Select eDP back light PWM Frequency.
ErP Function	Disabled[Default] Enabled	ErP Function (Deep S5).
PWR-On After PWR-Fail	Off[Default] On Last state	AC loss resume.
Wake Up by Ring	Disabled Enabled[Default]	Wake Up by Ring from S3/S4/S5.
Watch Dog	Disabled[Default] 30 sec 40 sec 50 sec 1 min 2 min 10 min 30 min	Select WatchDog.
USB Standby Power	Disabled Enabled[Default]	Enable/Disabled USB Standby Power during S3/S4/S5.
SHOW DMI INFO	Disabled[Default] Enabled	SHOW DMI INFO.

3.6.4 Security



- **Administrator Password**

Set setup Administrator Password

- **User Password**

Set User Password

3.6.4.1 Secure Boot



Item	Option	Description
Secure Boot	Disabled[Default] Enabled	Secure Boot feature is Active if Secure Boot is Enable, Platform Key(PK) is enrolled and the System is in User mode. The mode change requires platform reset.
Secure Boot Mode	Standard Custom[Default]	Secure Boot mode selector: Standard/Custom. In Custom mode Secure Boot Variables can be configured without authentication.

3.6.4.1.1 Key Management

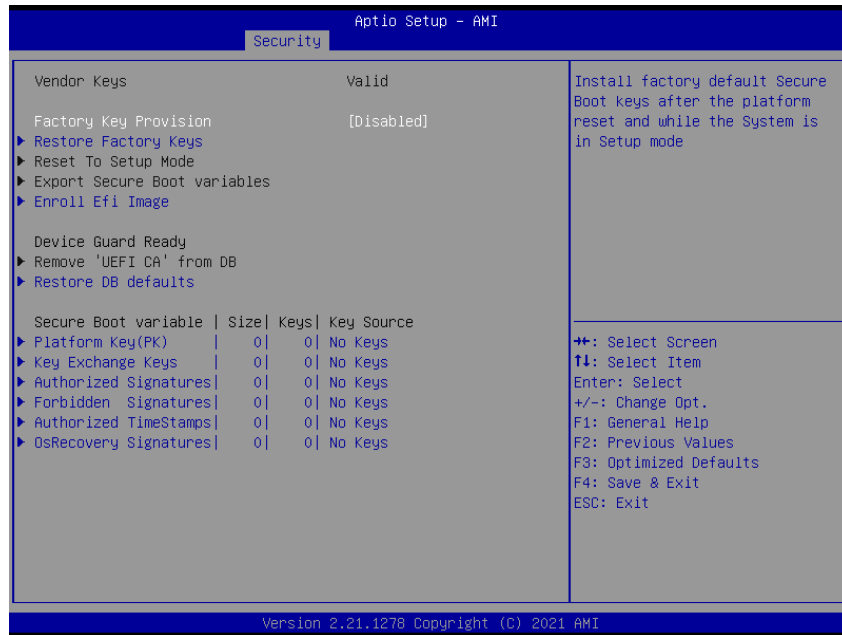

Item	Option	Description
Factory Key Provision	Disabled[Default] Enabled	Install factory default Secure Boot keys after the platform reset and while the System is in Setup mode.

3.6.5 Boot

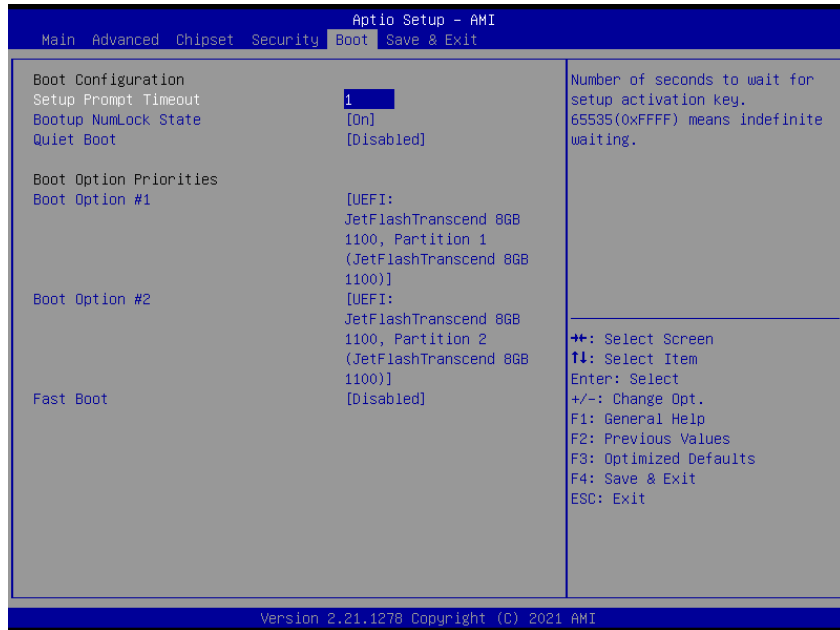

Item	Option	Description
Setup Prompt Timeout	1~ 65535	Number of seconds to wait for setup activation key. 65535(0xFFFF) means indefinite waiting.
Bootup NumLock State	On[Default] Off	Select the keyboard NumLock state
Quiet Boot	Disabled[Default] Enabled	Enables or disables Quiet Boot option
Fast Boot	Disabled[Default] Enabled	Enables or disables boot with initialization of a minimal set of devices required to launch active boot option. Has no effect for BBS boot options.
Boot Option #1/#2	Set the system boot order.	

3.6.6 Save and exit

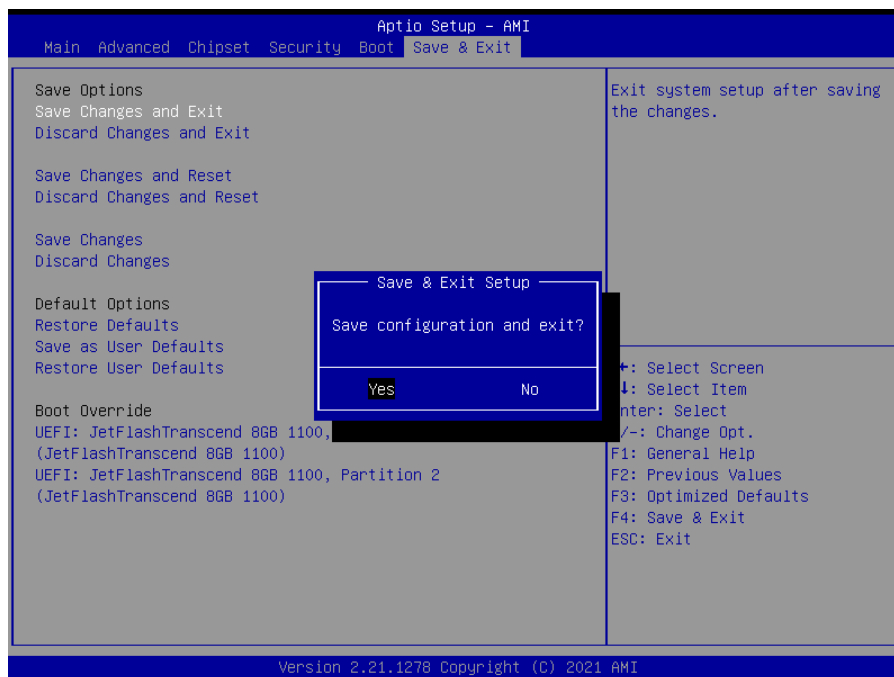
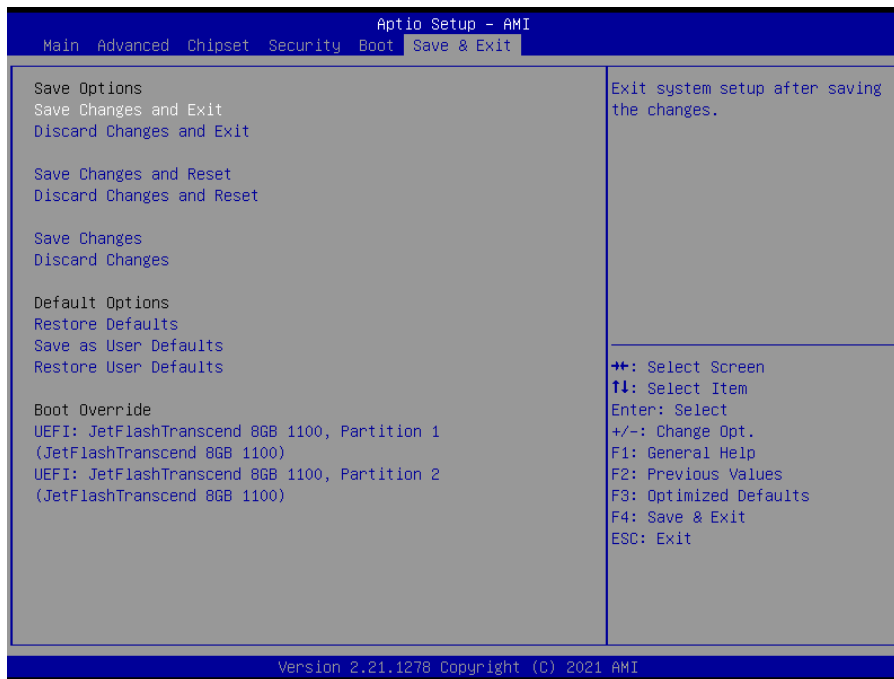

3.6.6.1 Save Changes and Exit

Use the save changes and reset option to save the changes made to the BIOS options and to exit the BIOS configuration setup program.

3.6.6.2 *Discard Changes and Exit*

Use the Discard changes and Exit option to exit the system without saving the changes made to the BIOS configuration setup program.

3.6.6.3 *Save Changes and Reset*

Reset the system after saving the changes.

3.6.6.4 *Discard Changes and Reset*

Any changes made to BIOS settings during this session of the BIOS setup program are discarded. The setup program then exits and reboots the controller.

3.6.6.5 *Save Changes*

Changes made to BIOS settings during this session are committed to NVRAM. The setup program remains active, allowing further changes.

3.6.6.6 *Discard Changes*

Any changes made to BIOS settings during this session of the BIOS setup program are discarded. The BIOS setup continues to be active.

3.6.6.7 *Restore Defaults*

This option restores all BIOS settings to the factory default. This option is useful if the controller exhibits unpredictable behavior due to an incorrect or inappropriate BIOS setting.

3.6.6.8 *Save as User Defaults*

This option saves a copy of the current BIOS settings as the User Defaults. This option is useful for preserving custom BIOS setup configurations.

3.6.6.9 *Restore User Defaults*

This option restores all BIOS settings to the user defaults. This option is useful for restoring previously preserved custom BIOS setup configurations.

4. Drivers Installation



Note: Installation procedures and screen shots in this section are for your reference and may not be exactly the same as shown on your screen.

4.1 Install Chipset Driver

All drivers can be found on the Avalue Official Website:

<http://www.avalu.com.tw>.



Note: The installation procedures and screen shots in this section are based on Windows 10 operation system. If the warning message appears while the installation process, click Continue to go on.



Step 3. Click Install.



Step1. Click Next.



Step 4. Setup completed.



Step 2. Click Accept.

4.2 Install ME Driver

All drivers can be found on the Avalue Official Website:

<http://www.avalu.com.tw>.



Note: The installation procedures and screen shots in this section are based on Windows 10 operation system. If the warning message appears while the installation process, click Continue to go on.

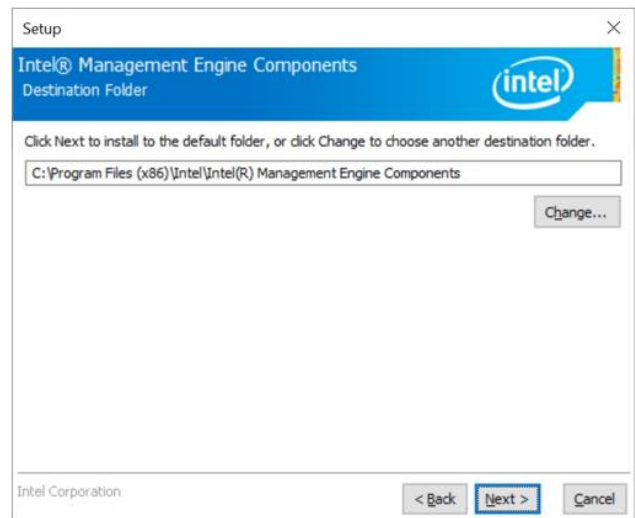

Step 3. Click **Next** to continue installation.

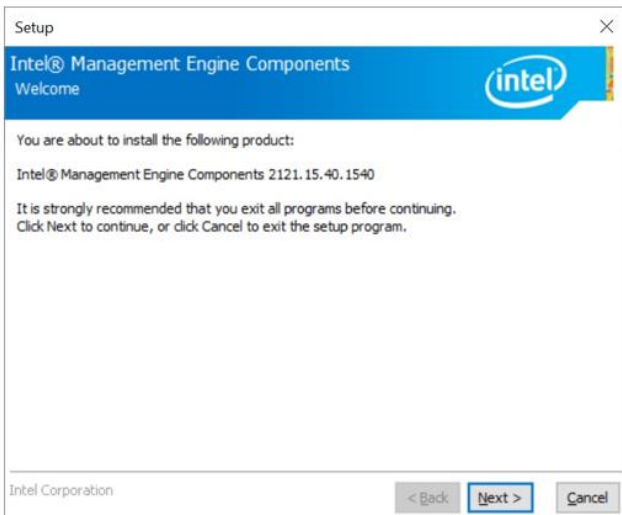

Step1. Click **Next** to start installation.

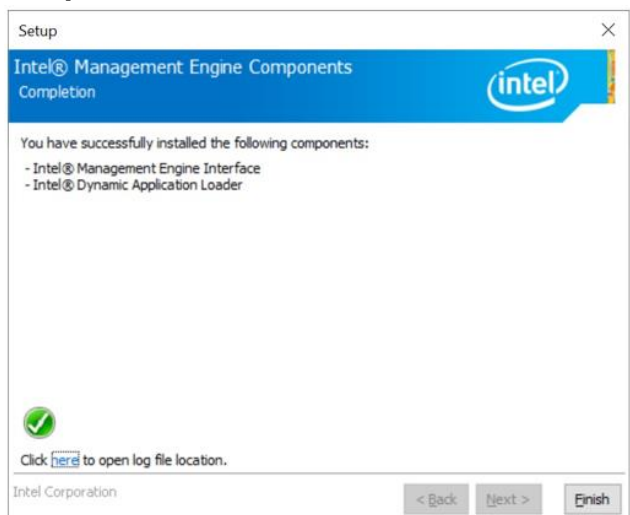

Step 4. Click **Finish** to complete setup.

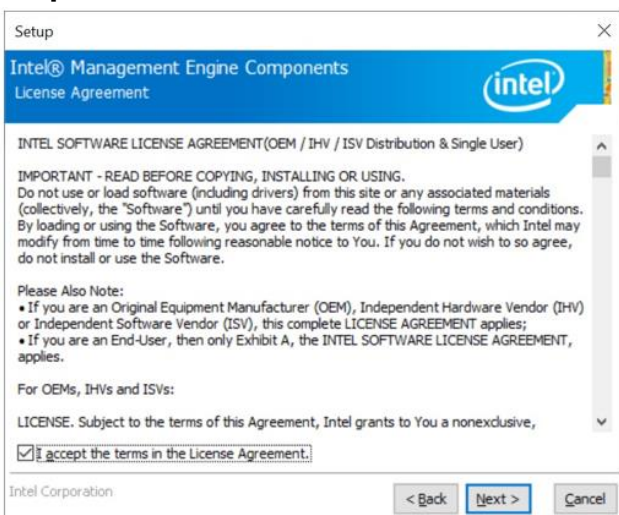

Step 2. Click **Next**.

4.3 Install VGA Driver

All drivers can be found on the Avalue Official Website:

<http://www.avalue.com.tw>.



Note: The installation procedures and screen shots in this section are based on Windows 10 operation system.

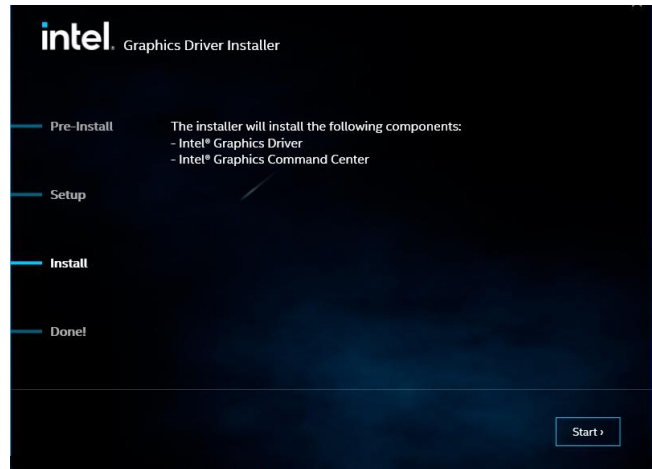

Step 3. Click Start.

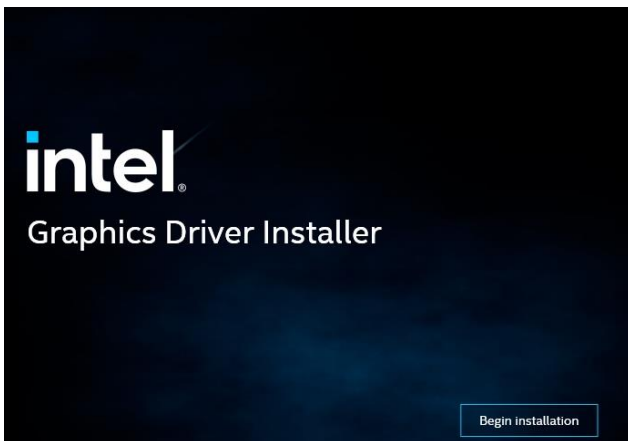

Step 1. Click Begin installation.

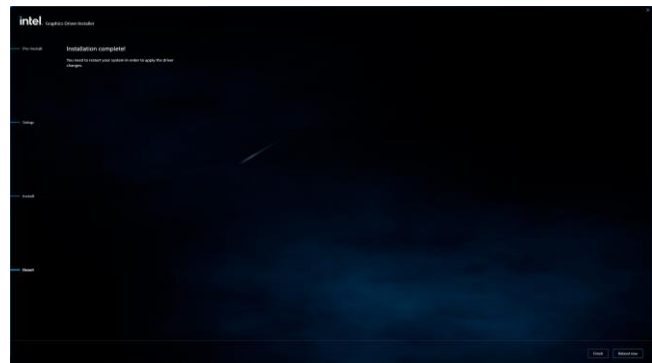

Step 4. Click Finish to complete setup.

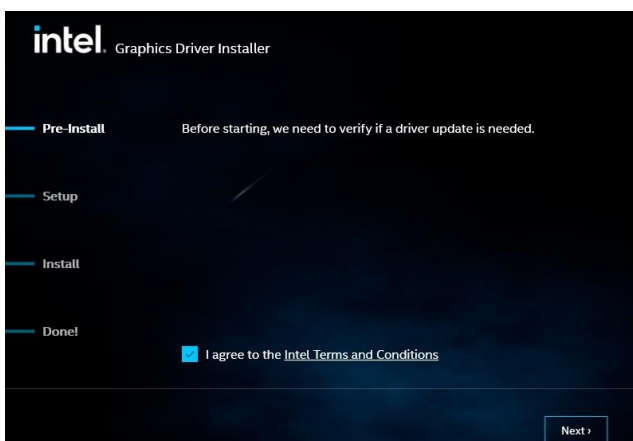

Step 2. Click Next.

4.4 Install Display Audio Driver

All drivers can be found on the Avalue Official Website:
<http://www.avalue.com.tw>.



Note: The installation procedures and screen shots in this section are based on Windows 10 operation system.

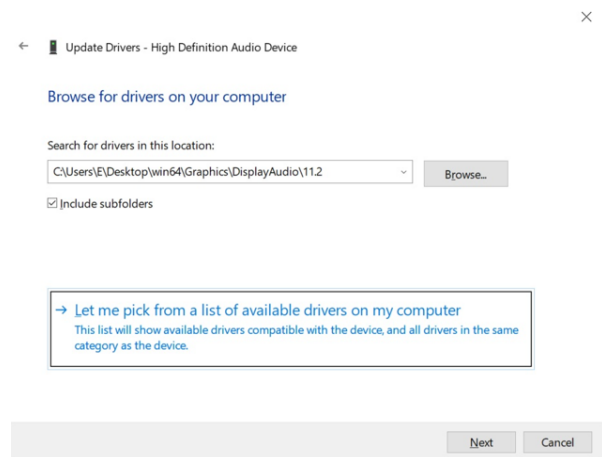

Step 3. Click Next.

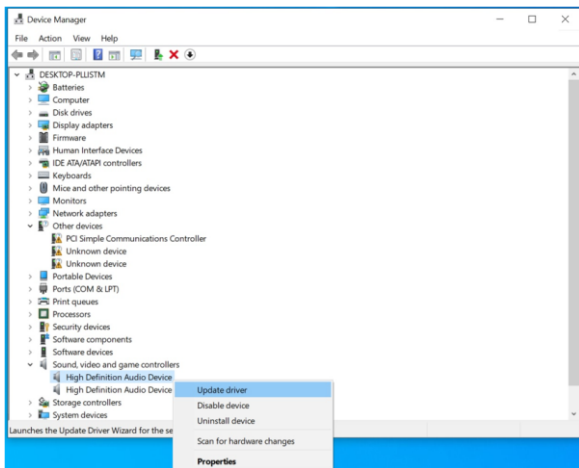

Step 1. Click Update Drivers.

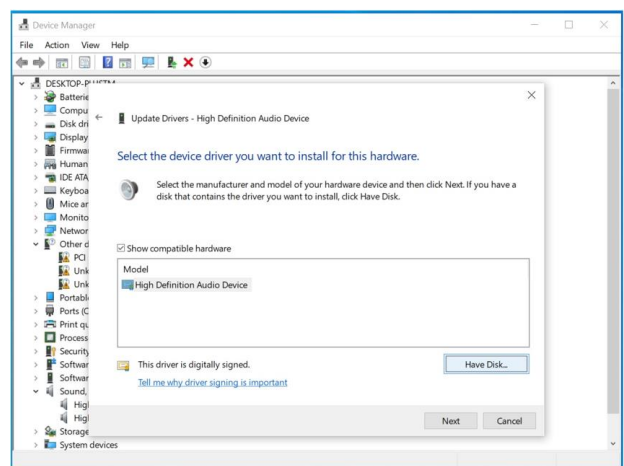

Step 4. Click Next.

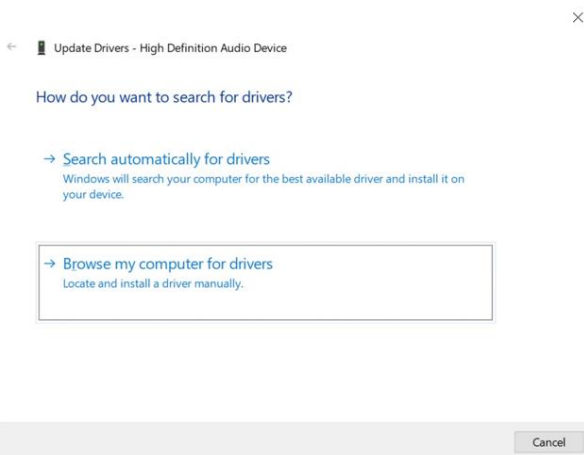

Step 2. Click Browse my computer for drivers.

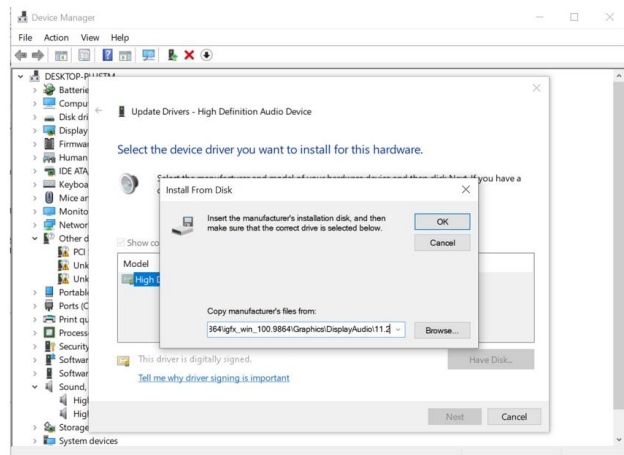

Step 5. Click OK.

ECM-EHL User's Manual

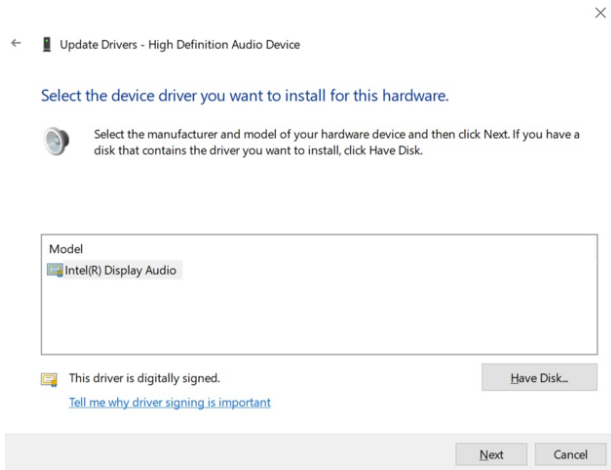

Step 6. Click Next.

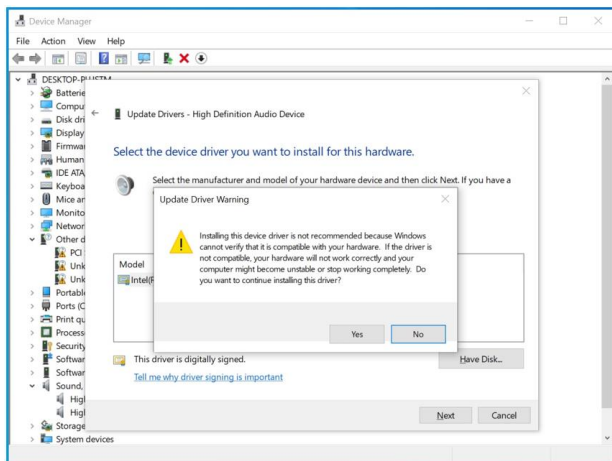

Step 7. Click Yes.

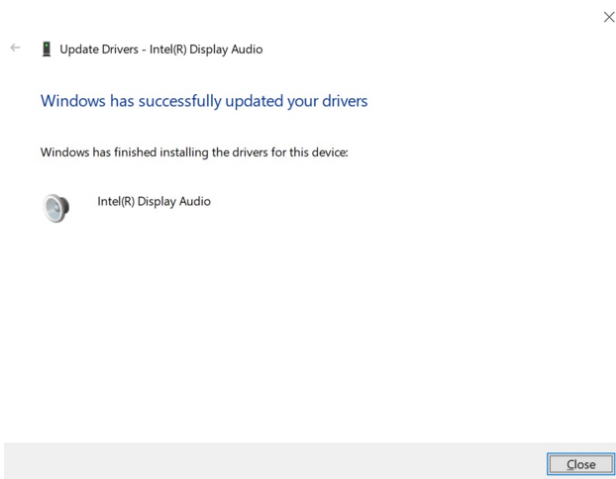

Step 8. Install complete.

4.5 Install Ethernet Driver

All drivers can be found on the Avalue Official Website:

<http://www.avalue.com.tw>.



Note: The installation procedures and screen shots in this section are based on Windows 10 operation system.

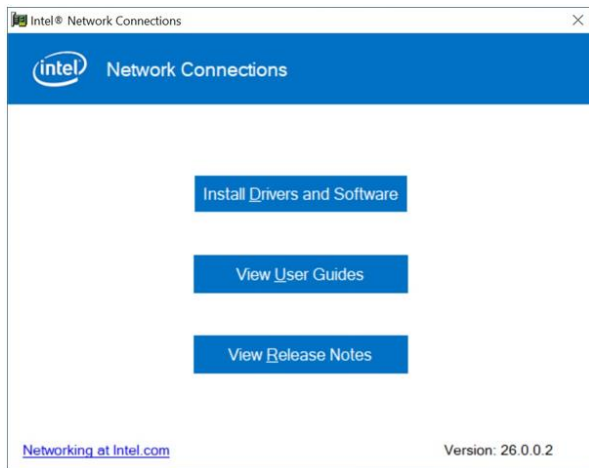

Step 1. Click Install Drivers and Software to continue installation.

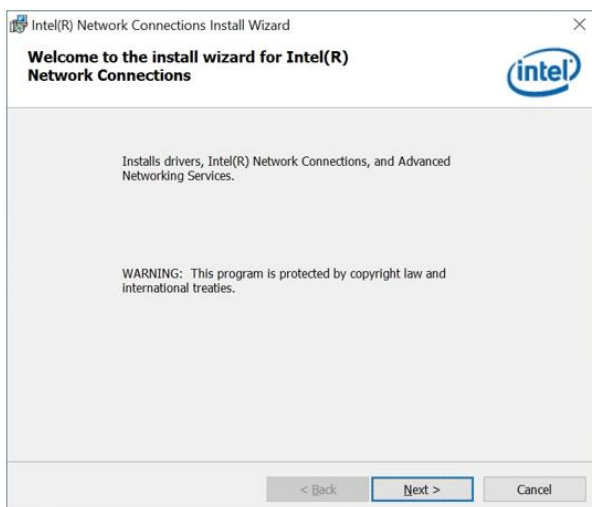

Step 2. Click Next.

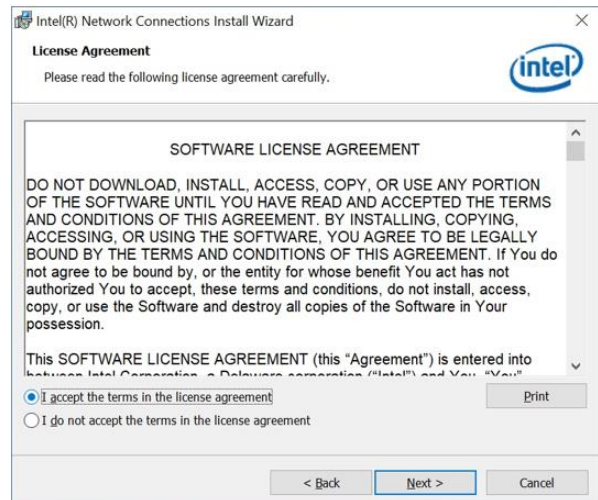

Step 3. Click Next.

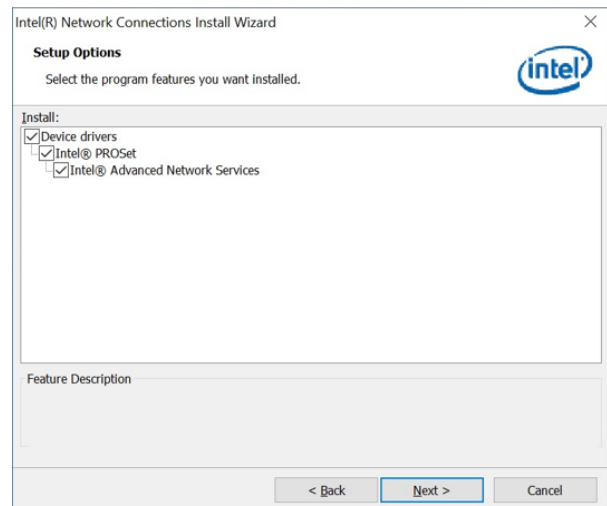

Step 4. Click Next.

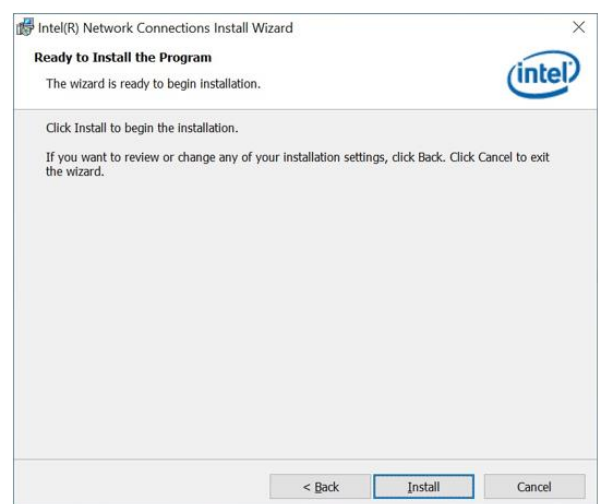

Step 5. Click Install.

ECM-EHL User's Manual

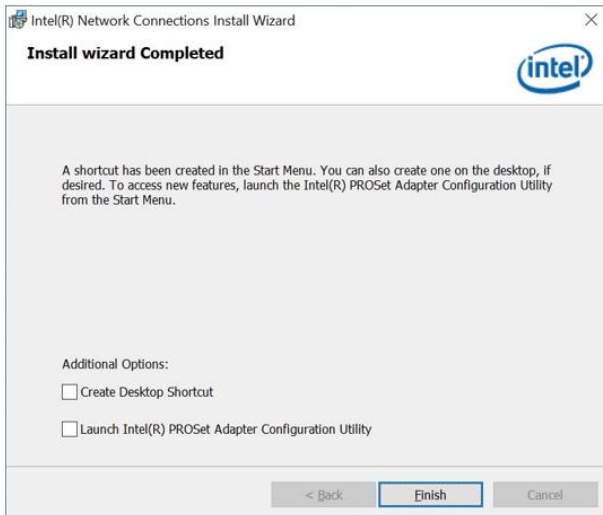

Step 6. Click **Finish** to complete setup.

4.6 Install HID Driver

All drivers can be found on the Avalue Official Website:
<http://www.avalue.com.tw>.



Note: The installation procedures and screen shots in this section are based on Windows 10 operation system.

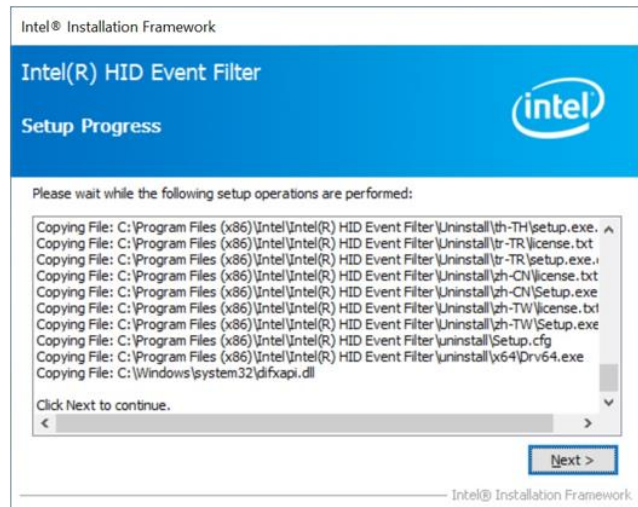

Step 3. Click Next.

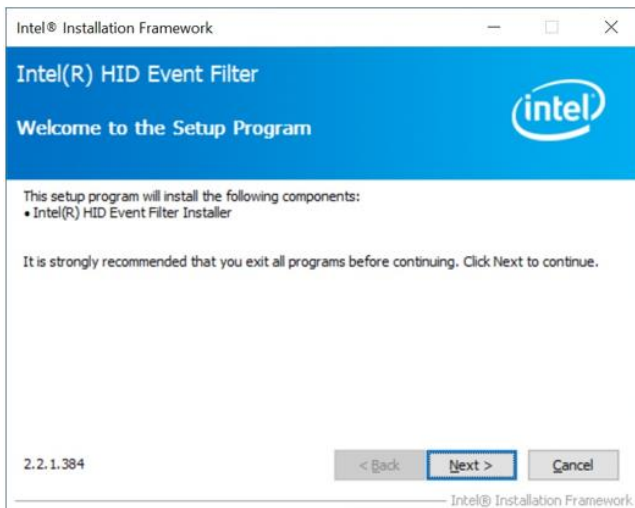

Step 1. Click Next to continue installation.

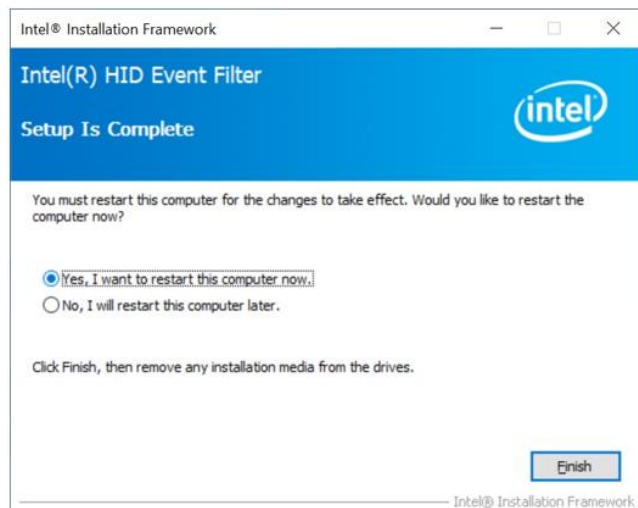

Step 4. Click Finish to complete setup.

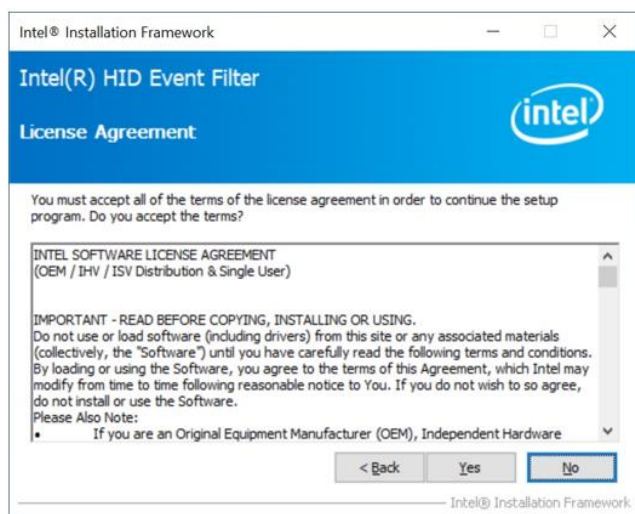

Step 2. Click Yes.

4.7 Install SIO Driver

All drivers can be found on the Avalue Official Website:

<http://www.avalu.com.tw>.



Note: The installation procedures and screen shots in this section are based on Windows 10 operation system.

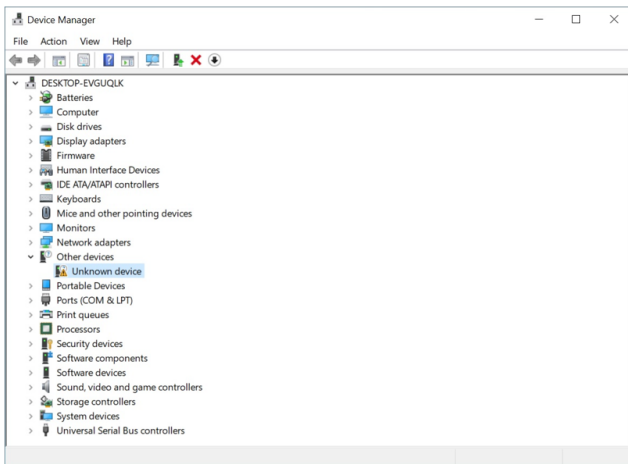

Step 1. Click **Unknown device** to continue installation.

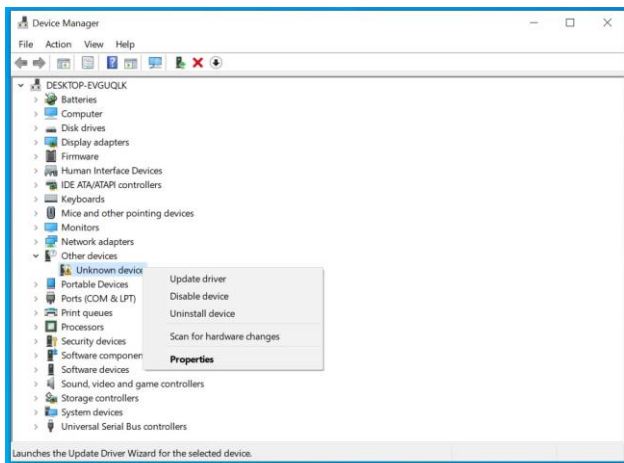

Step 2. Click **Update driver**.

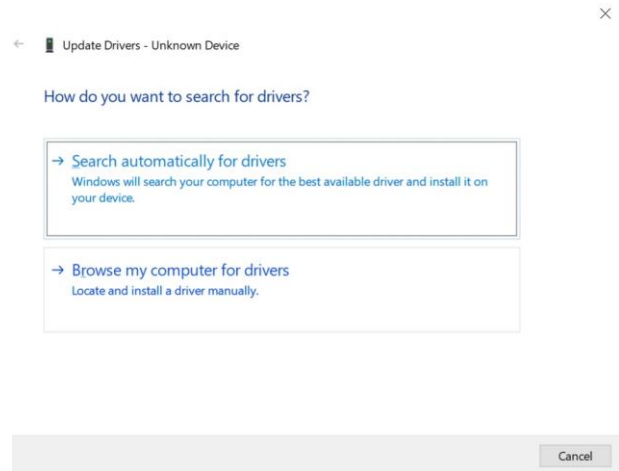

Step 3. Click **Search automatically for drivers**.

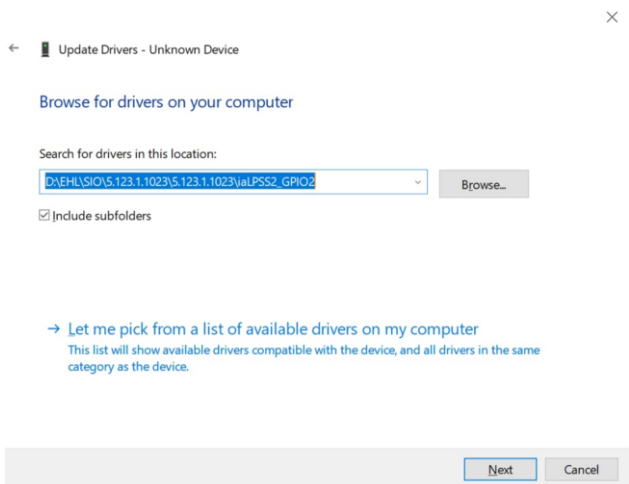

Step 4. Click **Next**.

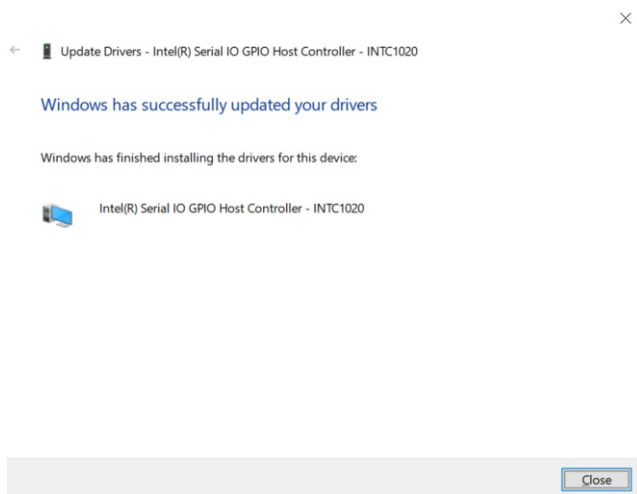

Step 5. Install complete.

5. Mechanical Drawing

ECM-EHL User's Manual

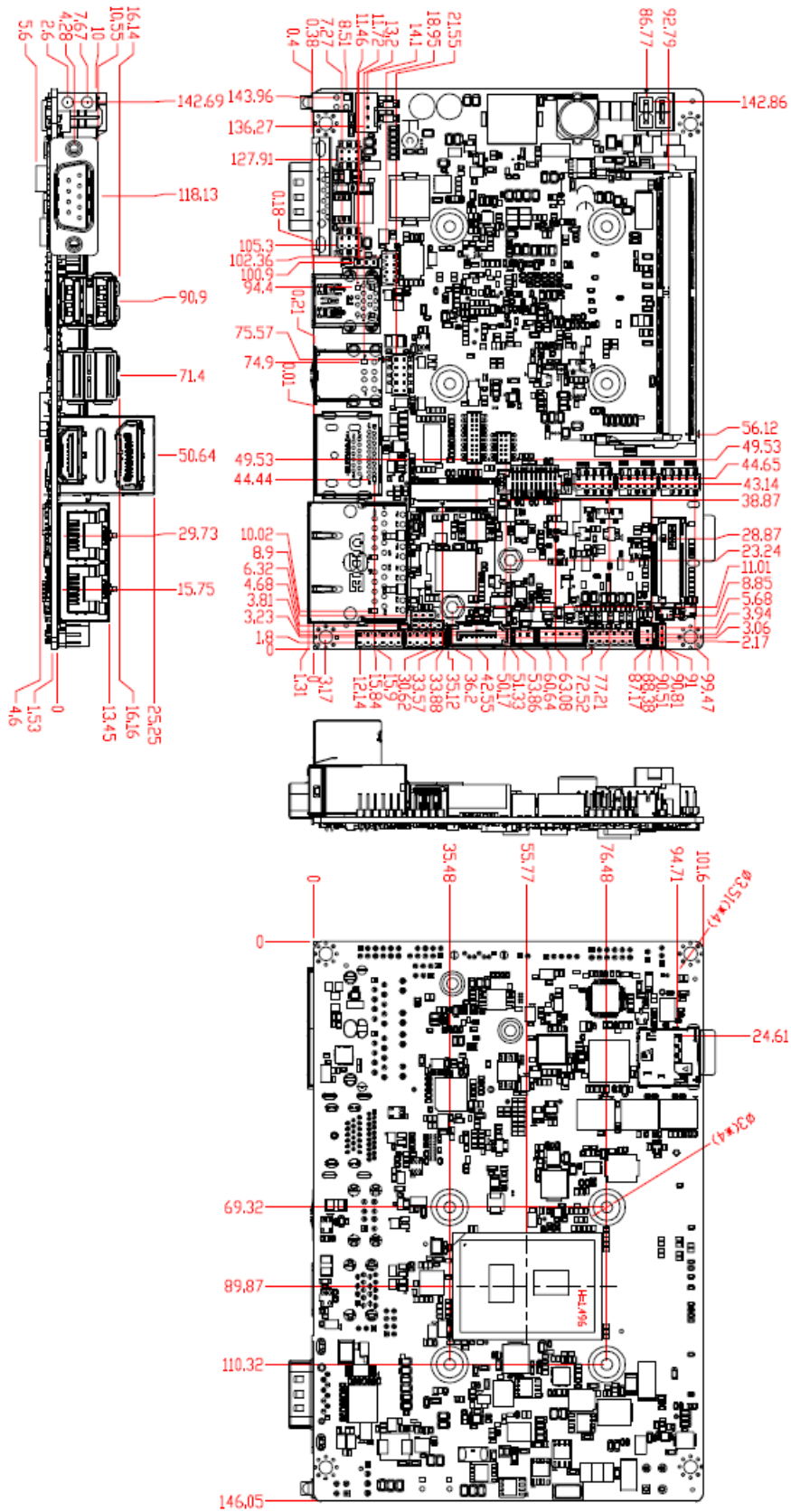

Unit: mm

